

VILLAGE OF DOWNERS GROVE
REPORT FOR THE VILLAGE COUNCIL MEETING
MARCH 8, 2011 AGENDA

SUBJECT:	TYPE:	SUBMITTED BY:
Pavement Patching	Resolution Ordinance ✓ Motion Discussion Only	Nan Newlon, P.E. Director of Public Works

SYNOPSIS

A motion is requested to authorize the award of a contract to Chicagoland Paving Contractors, Inc. of Lake Zurich, Illinois for 2011 pavement patching services in the amount of \$104,900.

STRATEGIC PLAN ALIGNMENT

The goals for 2011-2018 include *Top Quality Infrastructure*.

FISCAL IMPACT

The adopted FY11 Water Fund budget provides \$190,000 for street and parkway repairs required due to water utility excavations.

RECOMMENDATION

Approval on the March 15, 2011 consent agenda.

BACKGROUND

The contract for pavement patching was competitively bid for 2011, with three bids received as summarized below. The contract amount is based on patching approximately 650 square yards of pavement as well as smaller amounts of sidewalk and curb and gutter restoration generated as a result of water utility repairs.

Vendor	Bid Price
Chicagoland Paving Contractors, Inc., Lake Zurich, Illinois	\$104,900
Vian Construction Co., Inc., Elk Grove Village, Illinois	\$195,250
Construction Mgmt. Corp. of Illinois D/B/A Briggs Paving, Downers Grove, Illinois	\$211,450

The lowest responsive and responsible bidder is Chicagoland Paving Contractors, Inc. Chicagoland Paving completed this project the last two years at a similar cost and provided good quality results. They also provided positive references from the Villages of Winnetka, Wilmette and Woodridge, among others. Staff is confident that their work will meet the specifications required by the Village.

ATTACHMENTS

Contract Documents

Contractor Evaluation Form for 2010

Copy



CALL FOR BIDS – FIXED WORKS PROJECT

- I. Name of Company Bidding: Chicagoland Paving Contractors, Inc.
- II. Instructions and Specifications:
 - A. Bid No.: CFB-0-2011/TT
 - B. For: PAVEMENT PATCHING
 - C. Bid Opening Date/Time: FEBRUARY 3, 2011, 2:15 P.M.
Village Hall 801 Burlington Downers Grove, IL. 60515
 - D. Pre-Bid Conference Date/Time: N/A
 - E. Pre-Bid Conference Location: N/A
- III. Required of All Bidders:
 - A. Bid Deposit: 5%
 - B. Letter of Capability of Acquiring Performance Bond: YES
- IV. Required of Awarded Contractor(s)
 - A. Performance Bond or Letter of Credit: YES
 - B. Certificate of Insurance: YES

Legal Advertisement Published: JANUARY 20, 2011

This document comprises 42 pages

RETURN ORIGINAL BID IN SEALED ENVELOPE MARKED WITH THE BID NUMBER AS NOTED ABOVE TO:

THERESA H. TARKA
 DOWNERS GROVE PURCHASING ASSISTANT
 VILLAGE OF DOWNERS GROVE
 801 BURLINGTON
 DOWNERS GROVE, IL 60515
 PHONE: 630/434-5530
 FAX: 630/434-5571
www.downers.us

BID DATE 2/3/11
 BID TIME 2:15 pm
 REFUNDABLE YES ~~NO~~ N/A
 With Prints or-CD- YES (NO)

Village of Downers Grove

CALL FOR BIDS – FIXED WORKS PROJECT

Bid No.: CFB-0-2011/TT

The VILLAGE OF DOWNERS GROVE will receive bids Monday thru Friday, 8:00 A.M. to 5:00 P.M. at the Village Hall, 801 Burlington Avenue, Downers Grove, IL 60515.

The Village Council reserves the right to accept or reject any and all bids, to waive technicalities and to accept or reject any item of any Bid.

The documents constituting component parts of this contract are the following:

- I. CALL FOR BIDS
- II. TERMS & CONDITIONS
- III. GENERAL PROVISIONS
- IV. SPECIAL PROVISIONS
- V. BID & CONTRACT FORM

All Bidders MUST submit the entire bid package, with one original Bid Form. Upon formal Award, the successful Bid will automatically convert to a Contract, and the successful Bidder will receive a copy of the executed contract upon formal award of the Bid with the Notice of Award.

DO NOT DETACH ANY PORTION OF THIS DOCUMENT. INVALIDATION COULD RESULT.

I. CALL FOR BIDS and INSTRUCTIONS TO BIDDERS

1. GENERAL

- 1.1 Notice is hereby given that Village of Downers Grove will receive sealed bids up to:
FEBRUARY 3, 2011, 2:15 P.M.
- 1.2 Defined Terms:
 - 1.2.1 Village – the Village of Downers Grove acting through its officers or agents.
 - 1.2.2 Contract Documents – this document plus any drawings issued therewith, any addenda and the Bidder's completed proposal, bonds and all required certifications.
 - 1.2.3 Bid – this document completed by an individual or entity and submitted to the Village.
 - 1.2.4 Bidder – the individual or entity who submits or intends to submit a bid proposal to the Village.
 - 1.2.5 Contractor – the individual or entity whose bid is selected by the Village and who enters into a contract with the Village.
 - 1.2.6 Work – the construction or service defined herein.
 - 1.2.7 Day – unless otherwise stated all references to day "Day" "Days", "day" or "days" shall refer to calendar days.
 - 1.2.8 Proposal Guaranty – the required bid deposit.
- 1.3 Bids must be received at the Village by the time and date specified. Bids received after the specified time and date will not be accepted and will be returned unopened to the Bidder.
- 1.4 Bids shall be sent to the Village of Downers Grove, ATTN: Theresa Tarka, in a sealed envelope marked "SEALED BID". The envelope shall be marked with the name of the project, date, and time set for receipt of Bids. The bid package may be submitted any time prior to the time set for receipt of Bids.
- 1.5 All Bids must be submitted on the forms supplied by the Village and signed by a proper official of the company submitting Bid. Telephone, email and fax Bids will not be accepted.
- 1.6 Under penalty of perjury, the Bidder certifies by submitting this Bid that he has not acted in collusion with any other Bidder or potential Bidder.

2. BID PREPARATION

- 2.1 It is the responsibility of the Bidder to carefully examine the Contract Documents and to be familiar with all of the requirements, stipulations, provisions, and conditions surrounding the proposed Work.

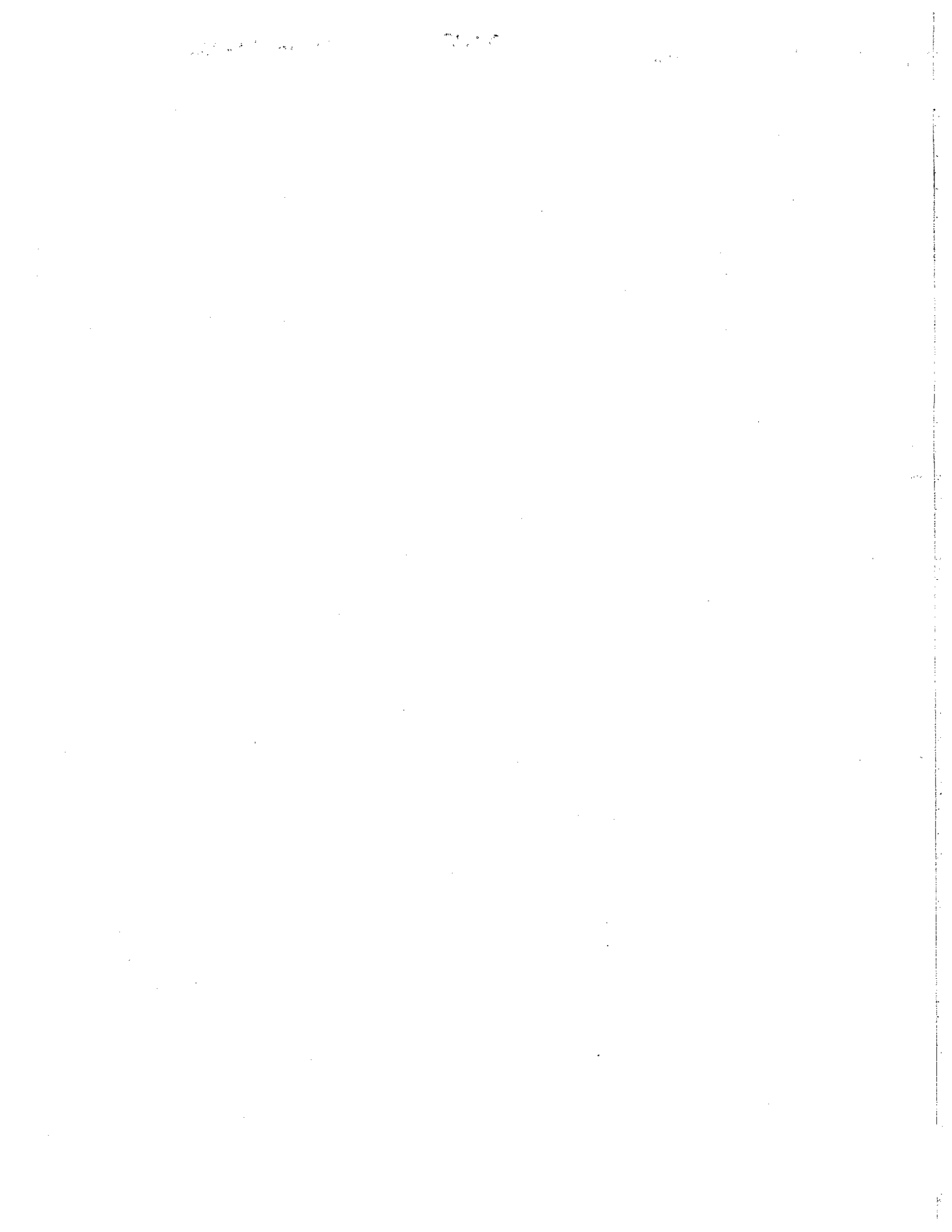

Village of Downers Grove

acknowledgement of receipt of each addendum issued with the bid submission.

- 2.6 An estimate of the quantities of Work to be performed and the materials to be furnished is shown in the Bid Form. It is given as a basis for comparing the properly submitted Bids, and shall be used by the Village in awarding the Contract. The Village does not expressly warrant nor imply that the estimated quantities shown will correspond with those quantities required to perform the Work. No Bidder shall plead misunderstanding or deception because of such an estimate of quantities, or because of the character, location or other conditions pertaining to the Work. Payment shall be based on the actual quantities of work properly performed in accordance with the Contract, at the Contract unit prices specified. The Village reserves the right to increase, decrease or omit entirely, any or all items. No allowance will be made for any change in anticipated profits due to an increase or decrease in the original estimate of quantities.
- 2.7 The Bidder must submit his proposal on the form furnished by the Village. The Bid shall be executed properly, and bids shall be made for all items indicated in the Bid Form. The Bidder shall indicate, in figures, a unit price or lump sum price for each of the separate items called for in the Bid Form. The Bidder shall show the products of the respective quantities and unit prices in the column provided for that purpose. The gross sum shown in the place indicated in the Bid Form shall be the summation of said products. All writing shall be with ink or typewriter, except the signature of the Bidder, which shall be written with ink.
- 2.8 In case of error in the extension of prices in the Bid, the hourly rate or unit price will govern. In case of discrepancy in the price between the written and numerical amounts, the written amount will govern.
- 2.9 All costs incurred in the preparation, submission, and/or presentation of any Bid including the Bidder's travel or personal expenses shall be the sole responsibility of the Bidder and will not be reimbursed by the Village.
- 2.10 The Bidder hereby affirms and states that the prices quoted herein constitute the total cost to the Village for all work involved in the respective items, as well as the materials to be furnished in accordance with the collective requirements of the Contract Documents. The Bidder also affirms that this cost includes all insurance, royalties, transportation charges, use of all tools and equipment, superintendence, overhead expense, profits and other work, services and conditions necessarily involved in the work to be done.
- 2.11 The Bidder shall complete and submit with the Bid an "Affidavit" (IDOT Form BC-57, or similar) listing all uncompleted contracts, including subcontract work; all pending low bids not yet awarded or rejected, and equipment available.
- 2.12 The Bidder shall complete and submit with the Bid a "Municipal Reference List" indicating other municipalities for which the Bidder has successfully performed similar work.
- 3. PRE-BID CONFERENCE**
- 3.1 A pre-bid conference may be offered to provide additional information, inspection or review of current facilities or equipment, and to provide an open forum for questions from Bidders. This pre-bid conference is not mandatory (unless stated "Required" on the cover of this document), but

Village of Downers Grove

attendance by Bidders is strongly advised as this will be the last opportunity to ask questions concerning the Bid.

3.2 For those unable to attend the meeting, questions may be posed in writing to the Village (faxed and emailed questions are acceptable), but must be received by the Village prior to the scheduled time for the pre-bid conference. Questions received will be considered at the conference. An addendum may be issued as a result of the pre-bid conference. Such an addendum is subject to the provisions for issuance of an addendum as set forth in the section titled "Addenda".

3.3 No Contract Documents will be issued after the pre-bid conference except to attendees.

4. BID SUBMISSION

4.1 An original copy of the sealed bid marked as indicated in Section 1 shall be submitted to the Village.

4.2 A bid deposit will be required, which shall not exceed ten percent (10%) of the estimated cost of the work to be furnished. Such bid deposit shall be in the form of a bid bond, certified check, cash or money order. Checks shall be drawn upon a bank of good standing payable to the order of the Village and said deposit shall be forfeited to the Village in the event the Bidder neglects or refuses to enter into a contract and bond when required, with approved sureties, to execute the Work or furnish the material for the price mentioned in his bid and according to the plans and specifications in case the contract shall be awarded to him.

4.3 Bids shall be publicly opened at the hour and place indicated above.

5. BID MODIFICATION OR WITHDRAWAL

5.1 A Bid that is in the possession of the Village may be altered by a letter bearing the signature or name of person authorized for submitting a Bid, provided that it is received prior to the time and date set for the bid opening. Telephone, email or verbal alterations of a Bid will not be accepted.

5.2 A Bid that is in the possession of the Village may be withdrawn by the bidder, up to the time set for the bid opening, by a letter bearing the signature or name of person authorized for submitting bids. Bids may not be withdrawn after the bid opening and shall remain valid for a period of ninety (90) days from the date set for the bid opening, unless otherwise specified.

5.3 Any bidder who does not submit a proposal is requested to return the enclosed Statement of "No Bid" postcard. Bidders not submitting proposals or "No Bid Statement" may otherwise be removed from our bid mailing list.

6. BID REJECTION

6.1 Bids that contain omissions, erasures, alterations, additions not called for, conditional bids or alternate bids not called for, or irregularities of any kind, shall be rejected as informal or insufficient. Bids otherwise acceptable, which are not accompanied by the proper Proposal Guaranty, shall also be rejected as informal or insufficient. The Village reserves the right however, to reject any or all bids and to waive such technical error as may be deemed best for the interest of the Village.

Village of Downers Grove

7. BIDDER COMPETENCY

- 7.1 No Bid will be accepted from or contract awarded to any person, firm or corporation that is in arrears or is in default upon any debt or contract. The Bidder, if requested, must present evidence to the Village of ability and possession of necessary facilities, and financial resources to comply with the terms of the Contract Documents. Evidence must be presented within three (3) business days.

8. BIDDER DISQUALIFICATION

- 8.1 Any one or more of the following causes may be considered as sufficient for the disqualification of a Bidder and the rejection of their Bid.

8.1.1 More than one Bid for the same Work from an individual, firm partnership, or corporation under the same or different names.

8.1.2 Evidence of collusion among Bidders.

8.1.3 Unbalanced Proposals in which the prices for some items are substantially out of proportion to the prices for other items.

8.1.4 Failure to submit a unit price for each item of Work listed in the Bid Form.

8.1.5 Lack of competency as revealed by financial statement or experience questionnaire.

8.1.6 Unsatisfactory performance record as shown by past work, judged from the standpoint of workmanship and progress.

8.1.7 Uncompleted work which, in the judgment of the Village, might hinder or prevent the prompt completion of this Work.

8.1.8 Failure to submit a signed Bidder's Certificate stating the following:

8.1.8.1 That the Bidder is not barred from bidding on this Contract as a result of a violation of Sections 720 ILCS 5/33-E3 and 720 ILCS 5/33-E4 of the Illinois Compiled Statutes; and

8.1.8.2 The Bidder is not delinquent in the payment of any tax administered by the Illinois Department of Revenue and;

8.1.8.3 The Bidder will maintain the types and levels of insurance required by the terms of this contract.

9. BASIS OF AWARD

- 9.1 The Village reserves the exclusive right to accept or reject any and all bids or to waive sections, technicalities and irregularities, or to accept or reject any Bid or any item of any Bid.

10. AWARD OF CONTRACT

- 10.1 Unless the Village exercises its right to reject all bids, the contract will be awarded to that

Village of Downers Grove

responsible Bidder whose Bid, conforming to the Contract Documents, will be most advantageous to the Village, price and other factors considered.

- 10.2 Unless otherwise specified, if a Contract is not awarded within ninety (90) days after the opening of bids, a Bidder may file a written request with the Village for the withdrawal of their Bid. The Village will have a maximum of ten (10) days after the receipt of such request to award the Contract or release the Bidder from further obligation by return of the Bidder's bid deposit. Any attempt or actual withdrawal or cancellation of a Bid by the awarded contractor who has been notified by the Village of the acceptance of said Bid shall be considered a breach of contract.

11. RETURN OF BID DEPOSIT

- 11.1 The bid deposit of all except the three (3) lowest responsive bidders on each contract will be returned within fifteen (15) days after the opening of bids. The remaining bid deposits of each contract will be returned within fifteen (15) days after the Village Council has awarded the contract and the required appurtenances to the contract have been received.

12. FAILURE TO ENTER INTO CONTRACT

- 12.1 Failure on the part of the successful Bidder to execute a Contract and provide acceptable bonds, as provided herein, within ten (10) days from the date of receipt of the Contract and Notice of Award from the Village, will be considered as just cause for the revocation of the award. The Bidder's bid security shall then be forfeited to the Village, not as a penalty but in payment of liquidated damages sustained as a result of such failure.
- 12.2 The Bidder shall not be allowed to claim lack of receipt where the Contract and Notice of Award was mailed by U.S. Postal Services certified mail to the business address listed in his bid. In case the Village does not receive evidence of receipt within ten (10) days of the date of Notice of Award, the Village may revoke the award. The Bidder shall then forfeit the bid security to the Village, not as a penalty but in payment of liquidated damages sustained as the result of such failure to execute the Contract.
- 12.3 By submitting a Bid, the Bidder understands and agrees that, if his proposal is accepted, and he fails to enter into a contract forthwith, he shall be liable to the Village for any damages the Village may thereby suffer.

13. SECURITY FOR PERFORMANCE

- 13.1 The successful Bidder shall, within ten (10) days after acceptance of the Bidder's proposal by the Village, furnish a Performance Bond and a Materials and Labor Payment Bond acceptable to the Village in the full amount of the bid. Said bonds shall guarantee the Bidder's performance under the Contract Documents and shall guarantee payment of all subcontractors and material suppliers. Any bond shall include a provision as will guarantee faithful performance of the Illinois Prevailing Wage Act, 820 ILCS 130/1 et seq.

14. TAX EXEMPTION

- 14.1 The Village is exempt from Illinois sales or use tax for direct purchases of materials and supplies. A copy of the Illinois Sales Tax Exemption Form will be issued upon request. Our federal identification number will also be provided to the selected Bidder.

Village of Downers Grove

15. RESERVED RIGHTS

- 15.1 The Village reserves the right to waive sections, irregularities, technicalities and informalities to this contract and to accept any Bid and to reject any and all Bids and to disapprove of any and all subcontractors as may be in the best interest of the Village. Time and date requirements for receipt of Bid, however, will not be waived.

16. CATALOGS AND SHOP DRAWINGS

- 16.1 Each Bidder shall submit catalogs, descriptive literature, and detailed drawings, where applicable, to fully illustrate and describe the work or material he proposes to furnish.

17. TRADE NAMES AND SUBSTITUTIONS

- 17.1 Certain materials and equipment are specified by a manufacturer or trade name to establish standards or quality and performance and not for the purpose of limiting competition. Products of other manufacturers may be substituted, if, in the opinion of the Village, they are equal to those specified in quality, performance, design, and suitability for intended use. If the Bidder proposes to furnish an "equal", the proposed "equal" item must be so indicated in the written bid. Where two or more items are specified, the selection among those specified is the Bidder's option, or he may submit his Bid on all such items. Detail specification sheets shall be provided by Bidder for all substituted items.

II. TERMS AND CONDITIONS

18. VILLAGE ORDINANCES

- 18.1 The successful bidder, now the Contractor, will strictly comply with all ordinances of the Village of Downers Grove and laws of the State of Illinois.

19. USE OF VILLAGE'S NAME

- 19.1 The Contractor is specifically denied the right of using in any form or medium the name of the Village for public advertising unless the Village grants express permission.

20. HOURS OF WORK

- 20.1 The Contractor shall do no work between the hours of 7:00 p.m. and 7:00 a.m., nor on Saturdays, Sundays or legal holidays, unless otherwise approved in writing by the Village. However, such work may be performed at any time if necessary, for the proper care and protection of work already performed, or in case of an emergency. All after-hour work is still subject to the permission of the Village.

21. PERMITS AND LICENSES

- 21.1 The Contractor shall obtain all necessary permits and licenses required to complete the Work. The cost of acquisition of all necessary permits, bonds, insurance and services as specified herein shall be considered INCIDENTAL, and no additional compensation will be allowed the Contractor.

22. INSPECTION

- 22.1 The Village shall have a right to inspect, by its authorized representative, any material, components or workmanship as herein specified. Materials, components or workmanship that have been rejected by the Village as not in accordance with the terms of the contract specifications

Village of Downers Grove

shall be replaced by the Contractor at no cost to the Village.

23. DELIVERIES

23.1 All materials shipped to the Village must be shipped F.O.B. designated location, Downers Grove, Illinois.

24. SPECIAL HANDLING

24.1 Prior to delivery of any product that is caustic, corrosive, flammable or dangerous to handle, the Contractor will provide written directions as to methods of handling such products, as well as the antidote or neutralizing material required for its first aid before delivery. Contractor shall also notify the Village and provide material safety data sheets for all substances used in connection with this contract which are defined as toxic under the Illinois Toxic Substances Disclosure to Employees Act.

25. NONDISCRIMINATION

25.1 Contractor shall, as a party to a public contract:

25.1.1 Refrain from unlawful discrimination in employment and undertake affirmative action to assure equality of employment opportunity and eliminate the effects of past discrimination;

25.1.2 By submission of this Bid, the Contractor certifies that he is an "equal opportunity employer" as defined by Section 2000(e) of Chapter 21, Title 42, U.S. Code Annotated and Executive Orders #11246 and #11375, which are incorporated herein by reference. The Equal Opportunity clause, Section 6.1 of the Rules and Regulations of the Department of Human Rights of the State of Illinois, is a material part of any contract awarded on the basis of this Bid.

25.2 It is unlawful to discriminate on the basis of race, color, sex, national origin, ancestry, age, marital status, physical or mental handicap or unfavorable discharge for military service. Contractor shall comply with standards set forth in Title VII of the Civil Rights Act of 1964, 42 U.S.C. Secs. 2000 et seq., The Human Rights Act of the State of Illinois, 68 ILL. Rev. Stat. Secs. 1-101 et seq., and The Americans With Disabilities Act, 42 U.S.C. Secs. 12101 et. seq.

26. SEXUAL HARASSMENT POLICY

26.1 The bidder, as a party to a public contract, shall have a written sexual harassment policy that:

26.1.1 Notes the illegality of sexual harassment;

26.1.2 Sets forth the State law definition of sexual harassment;

26.1.3 Describes sexual harassment utilizing examples;

26.1.4 Describes the bidder's internal complaint process including penalties;

26.1.5 Describes the legal recourse, investigative and complaint process available through the Illinois Department of Human Rights and the Human Rights Commission and how to

Village of Downers Grove

contact these entities; and

26.1.6 Describes the protection against retaliation afforded under the Illinois Human Rights Act.

27. EQUAL EMPLOYMENT OPPORTUNITY

27.1 In the event of the Contractor's non-compliance with the provisions of this Equal Employment Opportunity Clause, the Illinois Human Rights Act or the Rules and Regulations of the Illinois Department of Human Rights ("Department"), the Contractor may be declared ineligible for future contracts or subcontracts with the State of Illinois or any of its political subdivisions or municipal corporations, and the contract may be canceled or voided in whole or in part, and such other sanctions or penalties may be imposed or remedies invoked as provided by statute or regulation. During the performance of this contract, the Contractor agrees as follows:

27.1.1 That it will not discriminate against any employee or applicant for employment because of race, color, religion, sex, marital status, national origin or ancestry, age, physical or mental handicap unrelated to ability, sexual orientation, sexual identity, or an unfavorable discharge from military service; and further that it will examine all job classifications to determine if minority persons or women are underutilized and will take appropriate affirmative action to rectify any such underutilization.

27.1.2 That, if it hires additional employees in order to perform this contract or any portion thereof, it will determine the availability (in accordance with the Department's Rules and Regulations) of minorities and women in the area(s) from which it may reasonably recruit and it will hire for each job classification for which employees are hired in such a way that minorities and women are not underutilized.

27.1.3 That, in all solicitations or advertisements for employees placed by it or on its behalf, it will state that all applicants will be afforded equal opportunity without discrimination because of race, color, religion, sex, marital status, national origin or ancestry, age, physical or mental handicap unrelated to ability, or an unfavorable discharge from military services.

27.1.4 That it will send to each labor organization or representative of workers with which it has or is bound by a collective bargaining or other agreement or understanding, a notice advising such labor organization or representative of the bidder's obligations under the Illinois Human Rights Act and the Department's Rules and Regulations. If any such labor organization or representative fails or refuses to cooperate with the Contractor in its efforts to comply with such Act and Rules and Regulations, the Contractor will promptly so notify the Department and the contracting agency and will recruit employees from other sources when necessary to fulfill its obligations thereunder.

27.1.5 That it will submit reports as required by the Department's Rules and Regulations, furnish all relevant information as may from time to time be requested by the Department or the contracting agency, and in all respects comply with the Illinois Human Rights Act and the Department's Rules and Regulations.

27.1.6 That it will permit access to all relevant books, records, accounts and work sites by personnel of the contracting agency and the Department for purpose of investigation to

ascertain compliance with the Illinois Human Rights Act and the Department's Rules and Regulations.

27.1.7 That it will include verbatim or by reference the provisions of this clause in every subcontract it awards under which any portion of the contract obligations are undertaken or assumed, so that such provisions will be binding upon such subcontractor. In the same manner as with other provisions of this contract, the Contractor will be liable for compliance with applicable provisions of this clause by such subcontractors; and further it will promptly notify the contracting agency and the Department in the event any subcontractor fails or refuses to comply therewith. In addition, the Contractor will not utilize any subcontractor declared by the Illinois Human Rights Commission to be ineligible for contracts or subcontracts with the State of Illinois or any of its political subdivision or municipal corporations.

28. DRUG FREE WORK PLACE

28.1 Bidder, as a party to a public contract, certifies and agrees that it will provide a drug free workplace by:

28.1.1 Publishing a statement:

- (1) Notifying employees that the unlawful manufacture, distribution, dispensation, possession or use of a controlled substance, including cannabis, is prohibited in the Village's or Contractor's workplace.
- (2) Specifying the actions that will be taken against employees for violations of such prohibition.
- (3) Notifying the employee that, as a condition of employment on such contract or grant, the employee will:
 - (A) abide by the terms of the statement; and
 - (B) notify the employer of any criminal drug statute conviction for a violation occurring in the workplace no later than five (5) days after such conviction.

28.1.2 Establishing a drug free awareness program to inform employee's about:

- (1) the dangers of drug abuse in the workplace;
- (2) the Village's or Contractor's policy of maintaining a drug free workplace;
- (3) any available drug counseling, rehabilitation and employee assistance programs;
- (4) the penalties that may be imposed upon employees for drug violations.

28.1.3 Providing a copy of the statement required by subparagraph 11.1 to each employee engaged in the performance of the contract or grant and to post the statement in a prominent place in the workplace.

28.1.4 Notifying the contracting or granting agency within ten (10) days after receiving notice under part (3)(B) of paragraph 11.1 above from an employee or otherwise receiving actual notice of such conviction.

28.1.5 Imposing a sanction on, or requiring the satisfactory participation in a drug abuse assistance or rehabilitation program by any employee who is so convicted as required by section 5 of the Drug Free Workplace Act.

Village of Downers Grove

28.1.6 Assisting employees in selecting a course of action in the event drug counseling, treatment and rehabilitation is required and indicating that a trained referral team is in place.

28.1.7 Making a good faith effort to continue to maintain a drug free workplace through implementation of the Drug Free Workplace Act.

29. SUBSTANCE ABUSE PREVENTION ON PUBLIC WORKS PROJECTS ACT

29.1 In the event this is a public works project as defined under the Prevailing Wage Act, 820 ILCS 130/2, Contractor agrees to comply with the Substance Abuse Prevention on Public Works Projects Act, 820 ILCS 265/1 *et seq*, and further agrees that all of its subcontractors shall comply with such Act.. As required by the Act, Contractor agrees that it will file with the Village prior to commencing work its written substance abuse prevention program and/or that of its subcontractor(s) which meet or exceed the requirements of the Act.

30. PREVAILING WAGE ACT

30.1 Contractor agrees to comply with the Illinois Prevailing Wage Act, 820 ILCS 130/1 *et seq.*, for all work completed under this contract. Contractor agrees to pay the prevailing wage and require that all of its subcontractors pay prevailing wage to any laborers, workers or mechanics who perform work pursuant to this contract or related subcontract. For applicable rates, go to the State of Illinois – Department of Labor website and use the most current DuPage County rate.

30.2 Contractor and each subcontractor shall keep or cause to be kept an accurate record of names, occupations and actual wages paid to each laborer, workman and mechanic employed by the Contractor in connection with the contract. This record shall be open to inspection at all reasonable hours by any representative of the Village or the Illinois Department of Labor and must be preserved for four (4) years following completion of the contract.

30.3 Since this is a contract for a public works project, as defined in 820 ILCS 130/2, Contractor agrees to post at the job site in an easily accessible place, the prevailing wages for each craft or type of worker or mechanic needed to execute the contract or work to be performed.

30.4 Because this is a public works project as defined under the Prevailing Wage Act, 820 ILCS 130/2, any and all contractors and subcontractors must submit certified payroll records to the Village on a monthly basis. **WITHOUT THIS PAPERWORK, NO INVOICE SHALL BE PAID BY THE VILLAGE.** Contractors and subcontractors must also submit a statement affirming that the records are true and accurate, that the wages paid to each worker are not less than the prevailing rate, and that the contractor and subcontractor are aware that filing false records is a Class B misdemeanor. The records must include the name, address, telephone number, social security number, job classification, hours of work, hourly rate, and start and end time of work each day for every worker employed on the public work. The Village reserves the right to check the pay stubs of the workers on the job. The Village further cautions that payment for any services rendered pursuant to this contract may be predicated upon receipt of said records.

30.5 In the event that this is a construction project where Motor Fuel tax monies or state grant monies are used in the construction, maintenance and extension of municipal streets, traffic control signals, street lighting systems, storm sewers, pedestrian subways or overhead crossings, sidewalks

Village of Downers Grove

and off-street parking facilities, and the like, the Village will require an Apprenticeship and Training Certification, attached after the Bidder's Certification.

30.6 Any bond furnished as security for performance shall include a provision as will guarantee faithful performance of the Illinois Prevailing Wage Act, 820 ILCS 130/1 et seq.

31. PATRIOT ACT COMPLIANCE

The bidder represents and warrants to the Village that neither it nor any of its principals, shareholders, members, partners, or affiliates, as applicable, is a person or entity named as a Specially Designated National and Blocked Person (as defined in Presidential Executive Order 13224) and that it is not acting, directly or indirectly, for or on behalf of a Specially Designated National and Blocked Person. The bidder further represents and warrants to the Village that the bidder and its principals, shareholders, members, partners, or affiliates, as applicable are not, directly or indirectly, engaged in, and are not facilitating, the transactions contemplated by this Agreement on behalf of any person or entity named as a Specially Designated National and Blocked Person. The bidder hereby agrees to defend, indemnify and hold harmless the Village, and its elected or appointed officers, employees, agents, representatives, engineers and attorneys, from and against any and all claims, damages, losses, risks, liabilities and expenses (including reasonable attorney's fees and costs) arising from or related to any breach of the foregoing representations and warranties.

32. INSURANCE REQUIREMENTS

32.1 Prior to starting the work, Contractor and any Subcontractors shall procure, maintain and pay for such insurance as will protect against claims for bodily injury or death, or for damage to property, including loss of use, which may arise out of operations by the Contractor or Subcontractor or any Sub-Sub Contractor or by anyone employed by any of them, or by anyone for whose acts any of them may be liable. Such insurance shall not be less than the greater of coverages and limits of liability specified below or any coverages and limits of liability specified in the Contract Documents or coverages and limits required by law unless otherwise agreed to by the Village.

Workers Compensation	\$500,000	Statutory
Employers Liability	\$1,000,000	Each Accident
	\$1,000,000	Disease Policy Limit
	\$1,000,000	Disease Each Employee
Comprehensive General Liability	\$2,000,000	Each Occurrence
	\$2,000,000	Aggregate <i>(Applicable on a Per Project Basis)</i>
Commercial Automobile Liability	\$1,000,000	Each Accident
Professional Errors & Omissions	\$2,000,000	Each Claim
	\$2,000,000	Annual Aggregate

Village of Downers Grove

(pursuant to section.9 below)

Umbrella Liability \$ 5,000,000

- 32.2 Commercial General Liability Insurance required under this paragraph shall be written on an occurrence form and shall include coverage for Products/Completed Operations, Personal Injury with Employment Exclusion (if any) deleted, Blanket XCU and Blanket Contractual Liability insurance applicable to defense and indemnity obligations and other contractual indemnity assumed under the Contract Documents. The limit must be on a "Per Project Basis".
- 32.3 Comprehensive Automobile Liability Insurance required under this paragraph shall include coverage for all owned, hired and non-owned automobiles.
- 32.4 Workers Compensation coverage shall include a waiver of subrogation against the Village.
- 32.5 Comprehensive General Liability, Employers Liability and Commercial Automobile Liability Insurance may be arranged under single policies for full minimum limits required, or by a combination of underlying policies with the balance provided by Umbrella and/or Excess Liability policies.
- 32.6 Contractor and all Subcontractors shall have their respective Comprehensive General Liability (including products/completed operations coverage), Employers Liability, Commercial Automobile Liability, and Umbrella/Excess Liability policies endorsed to add the "Village of Downers, its officers, officials, employees and volunteers" as "additional insureds" with respect to liability arising out of operations performed; claims for bodily injury or death brought against Village by any Contractor or Subcontractor employees, or the employees of Subcontractor's subcontractors of any tier, however caused, related to the performance of operations under the Contract Documents. Such insurance afforded to the Village shall be endorsed to provide that the insurance provided under each policy shall be *Primary and Non-Contributory*.
- 32.7 Contractor and all Subcontractors shall maintain in effect all insurance coverages required by the Contract Documents at their sole expense and with insurance carriers licensed to do business in the State of Illinois and having a current A. M. Best rating of no less than A- VIII. In the event that the Contractor or any Subcontractor fails to procure or maintain any insured required by the Contract Documents, the Village may, at its option, purchase such coverage and deduct the cost thereof from any monies due to the Contractor or Subcontractor, or withhold funds in an amount sufficient to protect the Village, or terminate this Agreement pursuant to its terms.
- 32.8 All insurance policies shall contain a provision that coverages and limits afforded hereunder shall not be canceled, materially changed, non-renewed or restrictive modifications added, without thirty (30) days prior written notice to the Village. Renewal certificates shall be provided to the Village not less than five (5) prior to the expiration date of any of the required policies. All Certificates of Insurance shall be in a form acceptable to Village and shall provide satisfactory evidence of compliance with all insurance requirements. The Village shall not be obligated to review such certificates or other evidence of insurance, or to advise Contractor or Subcontractor of any deficiencies in such documents, and receipt thereof shall not relieve the Contractor or Subcontractor from, nor be deemed a waiver the right to enforce the terms of the obligations

hereunder. The Village shall have the right to examine any policy required and evidenced on the Certificate of Insurance.

- 32.9 If the Work under the Contract Documents includes design, consultation, or any other professional services, Contractor or the Subcontractor shall procure, maintain, and pay for Professional Errors and Omissions insurance with limits of not less than \$2,000,000 per claim and \$2,000,000 annual aggregate. If such insurance is written on a claim made basis, the retrospective date shall be prior to the start of the Work under the Contract Documents. Contractor and all Subcontractors agree to maintain such coverage for three (3) years after final acceptance of the Project by the Owner or such longer period as the Contract Documents may require. Renewal policies during this period shall maintain the same retroactive date.
- 32.10 Any deductibles or self-insured retentions shall be the sole responsibility of the Insured. At the option of the Village, either: the insurer shall reduce or eliminate such deductibles or self-insured retentions as respects the Village, its officers, officials, employees and volunteers; or the Contractor shall procure a bond guaranteeing payment of losses and related investigations, claim administration and defense expenses.

33. INDEMNITY AND HOLD HARMLESS AGREEMENT

- 33.1 To the fullest extent permitted by law, the Contractor shall indemnify, keep and save harmless the Village and its agents, officers, and employees, against all injuries, deaths, strikes, losses, damages, claims, suits, liabilities, judgments, costs and expenses, which may arise directly or indirectly from any negligence or from the reckless or willful misconduct of the Contractor, its employees, or its subcontractors.
- 33.2 The Contractor shall at its own expense, appear, defend and pay all charges of attorneys and all costs and other expenses arising therefrom or incurred in connection therewith, and, if any judgment shall be rendered against the Village in any such action, the Contractor shall, at its own expense, satisfy and discharge the same. This Agreement shall not be construed as requiring the Contractor to indemnify the Village for its own negligence. The Contractor shall indemnify, keep and save harmless the Village only where a loss was caused by the negligent, willful or reckless acts or omissions of the Contractor, its employees, or its Subcontractors.

34. SUBLETTING OF CONTRACT

- 34.1 No contract awarded by the Village shall be assigned or any part sub-contracted without the written consent of the Village. In no case shall such consent relieve the Contractor from his obligation or change the terms of this contract.

All approved sub-contracts shall contain language which incorporates the terms and conditions of this contract.

35. TERMINATION OF CONTRACT

- 35.1 The Village reserves the right to terminate the whole or any part of this contract, upon written notice to the Contractor, for any reason.
- 35.2 The Village further reserves the right to terminate the whole or any part of this contract, upon ten (10) days' written notice to the Awarded Bidder, in the event of default by the Contractor. Default

Village of Downers Grove

is defined as failure of the Contractor to perform any of the provisions of this contract or failure to make sufficient progress so as to endanger performance of this contract in accordance with its terms. In the event that the Contractor fails to cure the default upon notice, and the Village declares default and termination, the Village may procure, upon such terms and in such manner as it may deem appropriate, supplies or services similar to those so terminated. The Village may also contact the issuer of the Performance Bond to complete the Work. The Contractor shall be liable for any excess costs for such similar supplies or services. Any such excess costs incurred by the Village may be set-off against any monies due and owing by the Village to the Contractor.

36. BILLING AND PAYMENT PROCEDURES

- 36.1 Payment will be made upon receipt of an invoice referencing Village purchase order number. Once an invoice and receipt of materials or service have been verified, the invoice will be processed for payment in accordance with the Village's payment schedule. The Village will comply with the Local Government Prompt Payment Act, 50 ILCS 505/1 et seq., in that any bill approved for payment must be paid or the payment issued to the Contractor within 60 days of receipt of a proper bill or invoice. If payment is not issued to the Contractor within this 60 day period, an interest penalty of 1.0% of any amount approved and unpaid shall be added for each month or fraction thereof after the end of this 60 day period, until final payment is made.
- 36.2 The Village shall review each bill or invoice in a timely manner after its receipt. If the Village determines that the bill or invoice contains a defect making it unable to process the payment request, the Village shall notify the Contractor as soon as possible after discovering the defect pursuant to rules promulgated under 50 ILCS 505/1 et seq. The notice shall identify the defect and any additional information necessary to correct it.
- 36.3 As this contract is for work defined as a "fixed public work" project under the Illinois Prevailing Wage Act, 820 ILCS 130/2, any contractor or subcontractor is required to submit certified payroll records along with the invoice. No invoice shall be paid without said records.
- 36.4 Please send all invoices to the attention of: Village of Downers Grove, Accounts Payable, 801 Burlington, Downers Grove, IL 60515.

37. COMPLIANCE WITH OSHA STANDARDS

- 37.1 Equipment supplied to the Village must comply with all requirements and standards as specified by the Occupational Safety and Health Act. All guards and protectors as well as appropriate markings will be in place before delivery. Items not meeting any OSHA specifications will be refused.

38. CERCLA INDEMNIFICATION

- 38.1 The Contractor shall, to the maximum extent permitted by law, indemnify, defend, and hold harmless the Village, its officers, employees, agents, and attorneys from and against any and all liability, including without limitation, costs of response, removal, remediation, investigation, property damage, personal injury, damage to natural resources, health assessments, health settlements, attorneys' fees, and other related transaction costs arising under the Comprehensive Environmental Response, Compensation, and Liability Act (CERCLA) of 1980, 42 U.S.C.A. Sec. 9601, et seq., as amended, and all other applicable statutes, regulations, ordinances, and under common law for any release or threatened release of the waste material collected by the

Village of Downers Grove

Contractor, both before and after its disposal.

- 38.2 If the Contractor encounters any waste material governed by the above Act, it shall immediately notify the Village and stop working in the area until the above requirements can be met.

39. COPYRIGHT or PATENT INFRINGEMENT

- 39.1 The Contractor agrees to indemnify, defend, and hold harmless the Village against any suit, claim, or proceeding brought against the Village for alleged use of any equipment, systems, or services provided by the Contractor that constitutes a misuse of any proprietary or trade secret information or an infringement of any patent or copyright.

40. BUY AMERICA

- 40.1 The Contractor agrees to comply with 49 U.S.C.5323(j), the Federal Transportation Administration's (FTA) Buy America regulations at 49 C.F.R. Part 661, and any amendments thereto, and any implementing guidance issued by the FTA, with respect to this contract, when financed by Federal funds (through a grant agreement or cooperative agreement).

- 40.2 As a condition of responsiveness, the Contractor agrees to submit with its Bid submission, an executed Buy America Certificate, attached hereto.

41. CAMPAIGN DISCLOSURE

- 41.1 Any contractor, proposer, bidder or vendor who responds by submitting a bid or proposal to the Village of Downers Grove shall be required to submit with its bid submission, an executed Campaign Disclosure Certificate, attached hereto.
- 41.2 The Campaign Disclosure Certificate is required pursuant to the Village of Downers Grove Council Policy on Ethical Standards and is applicable to those campaign contributions made to any member of the Village Council.
- 41.3 Said Campaign Disclosure Certificate requires any individual or entity bidding to disclose campaign contributions, as defined in Section 9-1.4 of the Election Code (10 ILCS 5/9-1.4), made to current members of the Village Council within the five (5) year period preceding the date of the bid or proposal release.
- 41.4 By signing the bid documents, contractor/proposer/bidder/vendor agrees to refrain from making any campaign contributions as defined in Section 9-1.4 of the Election Code (10 ILCS 5/9-1.4) to any Village Council member and any challengers seeking to serve as a member of the Downers Grove Village Council.

42. GUARANTEE PERIOD

- 42.1 The Contractor shall provide a guarantee in writing covering a minimum period of one (1) year after approval and acceptance of the work. The Guarantee shall be in such form as the Village may prescribe, unless otherwise noted in the Specifications, and shall be submitted before receiving final payment. If longer guarantees are required, they will be noted in the Special Provisions for this project.

43. SUCCESSORS AND ASSIGNS

Village of Downers Grove

43.1 The terms of this Agreement will be binding upon and inure to the benefit of the parties and their respective successors and assigns; provided, however, that neither party will assign this Agreement in whole or in part without the prior written approval of the other. The Contractor will provide a list of key staff, titles, responsibilities, and contact information to include all expected sub-bidders.

44. WAIVER AND BREACH OF CONTRACT

44.1 The waiver by one party of any breach of this Agreement or the failure of one party to enforce at any time, or for any period of time, any of the provisions hereof will be limited to the particular instance and will not operate or be deemed to waive any future breaches of this Agreement and will not be construed to be a waiver of any provision except for the particular instance.

45. CHANGE ORDERS

45.1 The contract price is a "not-to-exceed" cost. At any time additional work is necessary or requested, and the not-to-exceed price is increased thereby, all parties must agree to any change, addition or price increase in writing.

45.2 Change orders for public works projects which authorize an increase in the contract price that is 50% or more of the original subcontract price or that authorize or necessitate any increase in the price of a subcontract under the contract that is 50% or more of the original subcontract price must be resubmitted for bidding in the same manner by which the original contract was bid. (50 ILCS 525/1)

46. SEVERABILITY OF INVALID PROVISIONS

46.1 If any provisions of this Agreement are held to contravene or be invalid under the laws of any state, country or jurisdiction, contravention will not invalidate the entire Agreement, but it will be construed as if not containing the invalid provision and the rights or obligations of the parties will be construed and enforced accordingly.

47. GOVERNING LAW

47.1 This Agreement will be governed by and construed in accordance with the laws of the State of Illinois. Venue is proper only in the County of DuPage for state cases or the Northern District of Illinois for federal cases.

48. NOTICE

48.1 Any notice will be in writing and will be deemed to be effectively served when deposited in the mail with sufficient first class postage affixed, and addressed to the party at the party's place of business. Notices shall be addressed to the Village as follows:

**Village Manager
Village of Downers Grove
801 Burlington Ave.
Downers Grove, IL 60515**

And to the Contractor as designated on the Contract Form.

49. AMENDMENT

49.1 This Agreement will not be subject to amendment unless made in writing and signed by all parties.

50. COOPERATION WITH FOIA COMPLIANCE

Contractor acknowledges that the Freedom of Information Act may apply to public records in possession of the Contractor or a subcontractor. Contractor and all of its subcontractors shall cooperate with the Village in its efforts to comply with the Freedom of Information Act . 5 ILCS 140/1 et.seq.

51. EMPLOYMENT OF ILLINOIS WORKERS ON PUBLIC WORKS ACT

If the work contemplated by this Contract is funded or financed in whole or in part with State Funds or funds administered by the State, Contractor agrees to comply with the terms of the Employment of Illinois Workers on Public Works Act by employing at least 90% Illinois laborers on the project. 30 ILCS 570/1 et seq. Contractor agrees further to require compliance with this Act by all of its subcontractors.

III. GENERAL PROVISIONS

1. STANDARD SPECIFICATIONS

1.1 The following standards shall govern the construction of the proposed improvements:

1.1.1 Standard Specifications for Water and Sewer Main Construction in Illinois, Fifth Edition, 1996 (the Water & Sewer Specs.); and

1.1.2 Standard Specifications for Road and Bridge Construction as adopted by the Illinois Department of Transportation, January 1, 2007; along with Supplemental Specifications and Recurring Special Provisions (collectively the "SSRBC") as adopted by the Illinois Department of Transportation, January 1, 2010; and

1.1.3 Water Distribution Specifications, Village of Downers Grove, Illinois, revised December, 2002.

1.2 These Contract Documents shall take precedence whenever there are conflicts in the wording or statements made by the above specifications and these Contract Documents.

1.3 Unless otherwise referenced herein, Division I of the Water and Sewer Specs and Section 102 and Articles 104.02, 104.03, 104.07, 107.02, 107.27, 107.35, 108.10, 108.11, and 108.12 of the SSRBC are hereby suspended.

2. COOPERATION OF CONTRACTOR

2.1 The Contractor will be supplied with a minimum of 2 sets of approved plans and contract assemblies including Special Provisions, one set of which the Contractor shall keep available on the work site at all times. The Contractor shall give the work site constant attention necessary to facilitate the progress thereof, and shall cooperate with the Village in every way possible.

2.2 The Contractor shall have on the work site at all times, as the Contractor's agent, a competent English-speaking representative capable of reading and thoroughly understanding the Contract Documents, and thoroughly experienced in the type of work being performed. The representative

Village of Downers Grove

shall also be capable of receiving instruction from the Village, and shall have full authority to promptly respond to such instruction. He shall be capable of supplying such materials, equipment, tools, labor and incidentals as may be required. The Contractor shall not replace him without prior written notification to the Village.

3. LEGAL REGULATIONS AND RESPONSIBILITY TO THE PUBLIC

3.1 Section 107 of the SSRBC shall govern the Contractor's legal regulations and responsibility to the public, with the following additions:

3.1.1 PROJECT SAFETY. Add the following to Article 107.28:

3.1.1.1 The Contractor shall conduct his work in such a manner as to provide an environment consistent with the safety, health and well being of those engaged in the completion of the work specified in this contract.

3.1.1.2 The Contractor shall comply with all State and Federal Safety Regulations as outlined in the latest revisions of the Federal Construction Safety Standards (Series 1926) and with applicable provisions regulations of the Occupation Safety and Health Administration and (OSHA) Standards of the Williams-Stelger Occupational Health Safety Act of 1970 (Revised). SPECIAL ATTENTION SHALL BE PAID TO COMPLIANCE WITH OSHA'S SUBPART P – EXCAVATIONS STANDARD.

3.1.1.3 The Contractor and Village shall each be responsible for their own respective agents and employees.

3.1.2 BACKING PRECAUTIONS. Pursuant to Sections 14-139(b) and 14-171.1 of the Downers Grove Municipal Code, any motor vehicle which has an obstructed view to the rear and is to be operated at any time in reverse gear on the public streets of the Village by the Contractor or any subcontractor shall either be equipped with a reverse signal alarm (backup alarm) audible above and distinguishable from the surrounding noise level, or shall provide an observer to signal that it is safe to back up.

3.1.3 OVERWEIGHT, OVERWIDTH AND OVERHEIGHT PERMITS. The Village has and supports an overweight truck enforcement program. Contractors are required to comply with weight requirements and safety requirements as established by Illinois Law or Village Ordinance, for vehicles, vehicle operators and specialty equipment. In some instances, specialty equipment for road repairs or construction projects requires the movement of overweight, overwidth, or overheight loads utilizing a Village roadway. Such movement will require obtaining a permit from the Village Police Department's Traffic Supervisor.

3.1.4 BARRICADES AND WARNING SIGNS. The Contractor shall provide the Village with a telephone number of a person or company who is available 24 hours per day, seven days per week, to erect additional barricades or signs. If the Village or his representative deems it necessary for the Public's safety to erect additional barricades or signs during normal working hours, the Contractor will furnish the necessary barricades or signs, and have them in place within 30 minutes. If, after normal working hours, the requested signs are not in

Village of Downers Grove

place within three hours after the request is made, the Village reserves the right to have the barricades and signs erected. The cost of erecting the barricades and signs shall be deducted by the Village from any payments due the Contractor.

4. PROSECUTION AND PROGRESS

4.1 Section 108 of the SSRBC shall govern the prosecution and progress of the work, with the following additions:

4.1.1 Prior to commencing construction, a meeting will be held with the Contractor and the Village. Any questions concerning procedures, general conditions, special provisions, plans or specific items related to the project shall be answered and clarified. No Pre-Construction meeting shall be scheduled until submittals, performance bonds, and certificates of insurance are delivered to, and approved by, the Village.

4.1.2 Weekly progress meetings may be required by the Village. If required, the Contractor shall have a capable person, such as a site superintendent or project manager, attend such meetings and be prepared to report on the prosecution of the Work according to the progress schedule.

5. MEASUREMENT AND PAYMENT

5.1 Section 109 of the SSRBC shall govern measurement and payment, with the following additions:

5.1.1 Modifies Article 109.07 - Partial payments will be made per Section 34 of Part II of this document (Billing and Payment Procedures.)

5.1.2 The Village will require that partial and final affidavits for all labor, materials and equipment used on the Project, be submitted with the partial and final payment requests. Such waivers shall indicate that charges for all labor, materials and equipment used on the project have been paid. Partial waivers from suppliers and subcontractors may be submitted after the first payment to the Contractor, and before the subsequent payment to that which they apply. However, partial waivers from the Contractor must accompany the invoice of the payment to which it applies. All final waivers, from all suppliers and subcontractors MUST accompany the Contractor's invoice upon submittal for final payment. A sworn statement by the Contractor shall accompany full waivers. Such requirement for full waivers is solely for the benefit of the Village and shall not be construed to benefit any other person. Partial payment for work done shall in no way imply acceptance of the work to that date.

IV. SPECIAL PROVISIONS

The following Special Provisions shall modify, supercede, or supplement the Standard Specifications referred to in Section III - General Provisions.

Where any section, subsection, paragraph, or subparagraph of the Standard Specifications is *supplemented* by any of the following paragraphs, the provisions of such section, subsection, paragraph, or subparagraph shall remain in effect. The Special Provisions shall govern in addition to the particular Standard Specification so supplemented, and not in lieu thereof.

Village of Downers Grove

Where any section, subsection, paragraph, or subparagraph of the Standard Specifications is *amended, voided, or superceded* by any of the following paragraphs, any provision of such section, subsection, paragraph, or subparagraph standing unaffected, shall remain in effect. The Special Provisions shall govern in lieu of any particular provision of the Standard Specification so amended, voided, or superceded, and not in addition to the portion changed.

Intent: The Village of Downers Grove (hereafter Village) desires to enter into a contract for pavement patching also including some curb and gutter, driveway and sidewalk repair. This Call for Bid is open to all contractors actively engaged in supplying the services as specified herein. Bidders will be required to demonstrate their capabilities through references or by means acceptable to the Village.

Scope: Work shall include, but not be limited to, all labor and materials required for the restoration of public and private areas in the Village that have been damaged by the excavation of the street due to repair of underground water utilities.

Bid Evaluation and Award: Bids will be compared and awarded on the basis of the total price bid for **Pavement Patching**, as listed on the Bid Sheet, with a not to exceed amount as approved in the fiscal year budget. The Village will also consider the quality of references for the prospective contractor. The Village reserves the right to accept or reject any or all bids and make the award(s) it deems in the best interest of the Village.

Contract Supervision: This contract will be under the direction of the Contract Administrator and detailed supervision of the contract shall be provided by the Contract Administrator or his authorized representatives. No claims for any extra work or materials shall be allowed without written authorization from the Contract Administrator.

Working Hours: The contractor will be allowed to schedule normal work hours between the hours of 7:00 a.m. and 7:00 p.m. Monday through Friday. Work during other hours will be allowed only as authorized by the Contract Administrator.

Right to Change Scope of Work: The quantities shown on the Bid Sheet are only for an illustrative purpose to enable the Village to uniformly evaluate bids. The amount of work detailed on the Bid Sheet is based on the Village's average experience. The contractor should not assume that the figures represent a guaranteed amount of work. Due to budget restrictions, the Village reserves the right to add or delete from the contract as required. No adjustments in contract unit prices or additional compensation will be made for decreases in the quantities or services from the contract. Quantities for each item are estimates only and may be altered.

Payment for Services: Payments will be made invoiced, after invoices have been verified by the Department of Public Works. **Payment will be based on the work orders.**

Contractors Representatives: The contractor shall provide a competent supervisor on the job at all times, who shall have full authority to act for the contractor and to receive and execute directives from the Contract Administrator. Any instructions given to such supervisor executing work for the contractor shall be binding on the contractor as though given to the contractor personally. Failure of the supervisor to act

Village of Downers Grove

on said directives shall be sufficient cause to give notice that the contractor is in default of the contract unless such directives would create potential personal injury or safety hazards. The contractor's supervisor must be proficient in the use and interpretation of the English language.

Safety: The contractor shall exercise every precaution at all times for the protection of persons and properties. The safety provisions of all applicable laws and ordinances shall be strictly observed. The contractor shall abide by all EPA and OSHA safety standards and regulations. **THE VILLAGE OF DOWNERS GROVE IS NOT RESPONSIBLE FOR SITE SAFETY. THE CONTRACTOR IS SOLELY AND EXCLUSIVELY RESPONSIBLE FOR THE MEANS, METHODS, AND TECHNIQUES AND ALL SITE SAFETY.**

Subcontracts: Subcontractors are subject to approval. The subcontractor, as approved, shall be bound by the conditions of the contract between the Village and the contractor and shall perform in accordance with all terms of the contract and specifications. All required notices, work orders, directives, and requests for emergency services will be directed to the contractor. All directions given to the subcontractor in the field shall bind the contractor as if the notice had been given directly to the contractor.

References: Bidders must submit with their bids a list of not less than five (5) current customers, including names and the addresses of facilities maintained by the prospective firm, and contact persons, with their daytime phone number, that can speak to the quality of services provided by the contract firm.

General Site Conditions: During typical underground utility repairs, a section of the sidewalk, curb and gutter or street pavement is removed. When repairs are completed on local streets, the excavated area is backfilled with CA-7, ¾" gravel and 4" of cold patch. Gravel and cold patch are to be removed from the area so that the area can be restored. These areas generally range in size from five to twenty square yards but may on occasion be smaller or larger.

General Direction for Repair: The Contract Administrator will mark with white marking paint and identify all areas to be restored. The typical work area will consist of an irregularly shaped area with either cold patch or an exposed gravel surface. Underground utility repair sites normally consist of compacted granular trench backfill. **The contractor shall remove the backfill as needed.** When directed by the Contract Administrator, any defective or unacceptable material installed by the contractor shall be removed and replaced in accordance with these specifications at no additional charge.

Expectations for Repair: All debris and spoil from the restoration operation shall be cleaned up before the work crew leaves the site. No debris or spoil shall be stockpiled for any reason. Debris and spoil are to be loaded onto a truck immediately. All lawn areas shall be raked clean, all streets and sidewalks shall be swept, and all debris and spoil shall be removed from the site. Areas are to be left in a condition equal to that which existed prior to the time when the damage occurred. Any and all necessary removal and hauling of unused material and all clean-up of the area shall be incidental to the contract.

Where turf areas are encountered next to repair (i.e. curb, sidewalk) the parkway shall be rough graded as to prevent an abrupt change in grade. Spoil that is free of aggregate shall be considered an acceptable turf grading material. Rough grading shall include the leveling of any tire ruts created during repair. Any and all necessary rough grading shall be incidental to the contract.

Village of Downers Grove

The Village anticipates issuing two (2) work orders. The first work order will be issued immediately and will comprise approximately 60% of the project cost. The second work order will be issued in September and will comprise approximately 40% of the project cost.

Timely Completion of Work: From the time that a work order is issued, the contractor shall have thirty (30) calendar days to complete all work as listed. Liquidated damages for failure to complete the work order work on time shall be assessed at \$500 per work day. Liquidated damages will accrue and be assessed until final completion of the work order and shall be deducted from any monies owed to the contractor.

Areas will be inspected at each specified location, after work is completed and the contractor has certified that his completed work complies with the contract specifications. The Contract Administrator reserves the right to reject any material or completed work which does not comply with these specifications. Payment for any and all work will not be made until the site has been completed, inspected, and accepted.

All work orders given to the contractor will show the size of the area to be restored and the type of work required.

SP-1 PAVEMENT PATCHING – CLASS C

Description: This work shall be performed in accordance with Articles 442 of the SSRBC, except as modified herein. This work shall consist of the replacement of temporary asphalt and aggregate with a permanent roadway patch. This work shall consist of either an 8 inch or 10 inch concrete sub-base, 1 ½ inch of level binder, and 1 ½ inch of surface mix as detailed in Village detail PVT-19 “Street Opening Bituminous with Concrete Base”. Reinforcement dowel bars shall not be required on streets without a concrete sub-base. This work shall be completed by an IDOT certified asphalt contractor.

Basis of Payment: This work will be paid for at the unit price per **SQUARE YARD** for **PAVEMENT PATCHING**, which price shall be payment in full for all labor, materials, and equipment necessary to complete the work described above and as indicated on plans. All pavement patching shall be paid for at the same unit price regardless of existing pavement thickness to be matched.

SP-2 PORTLAND CEMENT CONCRETE SIDEWALK

Description: This work shall consist of the replacement of P.C.C. sidewalk. All P.C.C. sidewalks shall be removed and placed by methods and with materials in accordance with Articles 424 and 1020.04 of the SSRBC, except as amended herein.

Removal of existing sidewalk shall include the saw cutting and disposal of existing concrete as directed by the Contract Administrator, the removal of tree roots, bituminous paved sidewalks and/or bituminous overlayment of existing sidewalks. Placement of sidewalk shall include the following:

- a) Any necessary excavation, clearing, and proper disposal of excavated materials;
- b) The placement of 4 inches of Type B, CA-6 compacted aggregate base;

Village of Downers Grove

- c) The set up of form work such that the maximum longitudinal slope of the finished walk does not exceed 8.33 percent (1 inch in 12 inches), and the lateral slope is not less than 1/4 inch per 12 inches, nor more than 1/2 inch per 12 inches.
- d) The placement of 5 inch thick, Class SI Portland Cement Concrete, 6.05 cwt/cy mix, with 6% air entrainment, 3 inch slump, and 6 inch thick through or in driveways or where subject to vehicular traffic, to the width specified on the plans or as directed by the Contract Administrator;
- e) The tooling of contraction joints, 3/4 inch radius and 1 inch deep, 5 feet on center;
- f) The placement of 3/4 inch thick premoulded expansion joints at 100 foot intervals on center, or abutting existing concrete sidewalk, or at the end of a pour;
- g) The adjustment to proper grade of all utility structures encountered;
- h) The proper curing of all concrete work utilizing methods and materials outlined in Articles 424 and 1022.01 of the SSRBC, (Type 2 membrane curing with red dye is preferred); and

Basis for Payment: This work shall be paid for at the contract unit price per SQUARE FOOT for **PORTLAND CEMENT CONCRETE SIDEWALK**, which price shall be payment in full for the work as specified herein.

SP3 COMBINATION CONCRETE CURB AND GUTTER REMOVAL AND REPLACEMENT, B6.12 OR B6.18

Description: This work shall consist of the removal and replacement of existing P.C.C. Curb and Gutter, or the placement of P.C.C. Curb and Gutter where none exist. All P.C.C. Curb and Gutter shall be removed and placed by methods and materials as specified in Articles 606 and 1020 of the SSRBC, except as amended herein.

Removal of Curb and Gutter shall include all necessary excavation; the disposal of excess materials; the saw cutting and removal of any overlayment of pavement, monolithic underlying base, or brick pavement. All adjoining pavement driveways, and/or sidewalk surface and base shall be repaired by methods and with materials approved by the Contract Administrator and shall be considered incidental to Combination Curb and Gutter removal and replacement, unless otherwise noted.

This work may also include the removal and replacement of existing sections of depressed curb and gutter for handicap ramps as indicated for new sidewalk construction, and where existing sidewalk is removed and replaced at crosswalks.

Placement of P.C.C. Combination Curb and Gutter shall include the following:

- a) The use of Class SI Portland cement concrete, 6.05 cwt/cy mix, with 6% air entrainment, 3 inch slump;
- b) The saw cutting of 2 inch deep joints at not more than 15-foot intervals, within 24 hours after

Village of Downers Grove

being placed;

- c) The placement of 2 dowel bars into the gutter portion of existing concrete curb, and at expansion joints, in accordance with the detail shown on the plans;
- d) The placement of 3/4 inch premoulded expansion joint filler perpendicular to the centerline of the roadway for the full depth of the curb and gutter, where abutting existing concrete curb and gutter, at 10 feet either side of a utility structure, at construction joints at the ends of pours, at not more than 90 foot intervals;
- e) The proper curing of all concrete work utilizing the methods and materials outlined in Articles 424 and 1022.01 of the SSRBC (Type 2 membrane curing with red dye is preferred);
- f) The backfilling of all curb work with materials approved by the Contract Administrator;
- g) All Curb and Gutter shall be monolithic and of the B6.12 or the B6.18 type.

Basis for Payment: This work shall be paid for at the contract unit price per LINEAR FOOT for **COMBINATION CONCRETE CURB AND GUTTER REMOVAL AND REPLACEMENT B6.12 or B6.18**, which price shall be payment in full for the work as specified herein.

SP-4 TRAFFIC CONTROL AND PROTECTION

Description: This item shall include the furnishing, installing, maintaining, relocating and removing all traffic control devices used for the purpose of regulating, warning, or directing traffic during the construction of this project. All traffic control devices used on this project shall conform to the SSRBC. No waiver of these requirements will be allowed without prior written approval of the Contract Administrator.

The contractor will be responsible for the proper location, installation, and arrangement of all traffic control devices during the period of construction. All open excavations for new sidewalk construction, or for sidewalk removal and replacement, shall be protected by Type I barricades equipped with bi-directional flashing lights in the following manner:

- a) Excavations for sidewalk placement less than 10 feet in length and 6 inches in depth shall have one Type I flashing barricade centered in the excavation.
- b) Excavations for sidewalk placement greater than 10 feet in length and 6 inches in depth shall have one Type I flashing barricade at each end of the excavation, as well as at 50-foot intervals between ends for excavations greater than 50 feet in length.

Additionally, similar barricades shall be affixed with a 10 inch x 15 inch informative "SIDEWALK CLOSED AHEAD" sign, which shall be placed at either end of the block, nearest the adjoining crosswalk location, for all areas of sidewalk excavation.

A minimum of four barricades shall be required per location. The Contractor shall plan his work so that all barricades used for traffic control and not protecting open excavations will be removed from pavement areas during non-working hours.

All contractors or subcontractors that need to cause a street disturbance will be required to temporarily install traffic control devices, as appropriate for that work. Failure to do so will result in the project being halted. The procedures are located at: <http://www.downers.us/publicworks/traffic>

Basis of Payment: This work shall be paid for at the contract LUMP SUM price for **TRAFFIC CONTROL AND PROTECTION**, which price shall be payment in full for the work as specified herein.

SP-5 BITUMINOUS DRIVEWAY PAVEMENT, 3"

Description: This work shall consist of the removal and replacement of asphalt driveways. The asphalt (hot mix) shall be placed upon a minimum of 6 inches of Type CA-6 Aggregate base, and shall consist of a minimum of two 1-½ inch lifts of compacted Hot-Mix Asphalt, Mix C, N50, IL-9.5. The asphalt shall also be placed by methods and materials outlined in Articles 406 and 1030 of the SSRBC. This work shall be completed by an IDOT certified asphalt contractor, in accordance to IDOT and Village public right-of-way specifications. All areas of work shall be properly excavated, prepared, and compacted. All edges that meet graded parkway areas shall be neatly tampered. A minimum of two separate 1.5 inch compacted lifts of surface course shall be applied.

Basis of Payment: This work shall be paid for at the contract unit prices per SQUARE YARD for **BITUMINOUS DRIVEWAY PAVEMENT 3"**, which price shall be payment in full for the preparation of the area to be paved, the proper disposal of excavated and surplus materials, and the placement of bituminous concrete materials. Compensation for locations where thicker asphalt is required shall be based on a direct ratio of the thickness to be met.

SP-6 PORTLAND CEMENT CONCRETE (P.C.C.) DRIVEWAY REMOVAL AND REPLACEMENT

Description: This work shall consist of the removal and replacement of Portland Cement Concrete driveways. The base course shall consist of a minimum of 6 inches of Type CA-6 aggregate base, measured after placement and compaction. The surface course shall consist of a minimum 6 inches of Class PV Portland Cement Concrete. The driveway shall be placed by methods and materials outlined in Section 423 and Article 1020.04 of the SSRBC.

All concrete work shall be properly cured utilizing the materials and methods outlined in Section 1022 of the SSRBC; except that Type II cure and seal compound with no dye shall be used.

Basis of Payment: This work will be paid for at the contract unit price per SQUARE YARD for **P.C.C. DRIVEWAY REMOVAL AND REPLACEMENT**, which price shall be payment in full for the preparation of the area to be paved, the proper disposal of excavated and surplus materials, and the placement of P.C.C. materials. All driveway replacement shall be paid for at the same unit price irregardless of existing pavement thickness to be matched.

Village of Downers Grove

V. BID and CONTRACT FORM (Village)

***THIS BID WHEN ACCEPTED AND SIGNED BY AN AUTHORIZED SIGNATORY OF THE VILLAGE OF DOWNERS GROVE SHALL BECOME A CONTRACT BINDING UPON BOTH PARTIES.

Entire Form Must Be Completed If a Submitted Bid Is To Be Considered For Award

BIDDER:

Chicagoland Painting Contractors
Company Name

2.3.2011
Date

225 Telser Rd.
Street Address of Company

chicagoland1@sbcglobal.net
E-mail Address

Lake Zurich, IL 60077
City, State, Zip

William Bowes
Contact Name (Print)

847-550-9681
Business Phone

847-417-1133
24-Hour Telephone

847-550-9684
Business Fax

W R Bowes
Signature of Officer, Partner or Sole Proprietor

ATTEST: if a Corporation

William Bowes, V.P.
Print Name & Title

W. R. Bowes
Signature of Corporation Secretary

We hereby agree to furnish the Village of Downers Grove all necessary materials, equipment, labor, etc. to complete any submitted phase of the project within 30 calendar days from the date of the initial or any subsequent Notice to Proceed in accordance with the provisions, instructions and specifications for the unit prices shown on the Schedule of Prices.

VILLAGE OF DOWNERS GROVE:

ATTEST:

Authorized Signature

Village Clerk

Title

Date

Date

In compliance with the specifications, the above-signed offers and agrees, if this Bid is accepted within 90 calendar days from the date of opening, to furnish any or all of the services upon which prices are quoted, at the price set opposite each item, delivered at the designated point within the time specified above.

V. BID and CONTRACT FORM (Contractor)

*****THIS BID WHEN ACCEPTED AND SIGNED BY AN AUTHORIZED SIGNATORY OF THE VILLAGE OF DOWNERS GROVE SHALL BECOME A CONTRACT BINDING UPON BOTH PARTIES.**

Entire Form Must Be Completed If a Submitted Bid Is To Be Considered For Award

BIDDER:

Chicagoland Paving Contractors, Inc. 2/3/2011
Company Name Date

225 Telser Rd. chicagoland1@shcglobal.net
Street Address of Company E-mail Address

Lake Zurich IL 60047 William Banes
City, State, Zip Contact Name (Print)

847-550-9681 847-417-1133
Business Phone 24-Hour Telephone

847 550-9684 W R Banes
Business Fax Signature of Officer, Partner or Sole Proprietor

ATTEST: if a Corporation
W R Banes
Signature of Corporation Secretary
William Banes, V.P.
Print Name & Title

We hereby agree to furnish the Village of Downers Grove all necessary materials, equipment, labor, etc. to complete any submitted phase of the project within 30 calendar days from the date of the initial or any subsequent Notice to Proceed in accordance with the provisions, instructions and specifications for the unit prices shown on the Schedule of Prices.

VILLAGE OF DOWNERS GROVE:

ATTEST:

Authorized Signature

Village Clerk

Title

Date

In compliance with the specifications, the above-signed offers and agrees, if this Bid is accepted within 90 calendar days from the date of opening, to furnish any or all of the services upon which prices are quoted, at the price set opposite each item, delivered at the designated point within the time specified above.

BIDDER'S CERTIFICATION (page 1 of 3)

With regard to Pavement Patching, bidder Chicago Land Paving Contractors
(Name of Project) (Name of Bidder)
hereby certifies the following:

1. Bidder is not barred from bidding this contract as a result of violations of Section 720 ILCS 5/33E-3 (Bid Rigging) or 720 ILCS 5/33E-4 (Bid-Rotating);
2. Bidder certifies that it has a written sexual harassment policy in place and full compliance with 775 ILCS §12-105(A)(4);
3. Bidder certifies that not less than the prevailing rate of wages as determined by the Village of Downers Grove, DuPage County or the Illinois Department of Labor shall be paid to all laborers, workers and mechanics performing work for the Village of Downers Grove. All bonds shall include a provision as will guarantee the faithful performance of such prevailing wage clause. Bidder agrees to comply with the Illinois Prevailing Wage Act, 820 ILCS 130/1 *et seq.*, for all work completed. Bidder agrees to pay the prevailing wage and require that all of its subcontractors pay prevailing wage to any laborers, workers or mechanics who perform work pursuant to this contract or related subcontract. Bidder and each subcontractor shall keep or cause to be kept an accurate record of names, occupations and actual wages paid to each laborer, workman and mechanic employed by the Bidder in connection with the contract. This record shall be sent to the Village on a monthly basis along with the invoice and shall be open to inspection at all reasonable hours by any representative of the Village or the Illinois Department of Labor and must be preserved for four (4) years following completion of the contract. Bidder certifies that bidder and any subcontractors working on the project are aware that filing false payroll records is a class B misdemeanor and that the monetary penalties for violations are to be paid pursuant to law by the bidder, contractor and subcontractor. The Village shall not be liable for any underpayments. If applicable: Since this is a contract for a fixed public works project, as defined in 820 ILCS 130/2, Contractor agrees to post at the job site in an easily accessible place, the prevailing wages for each craft or type of worker or mechanic needed to execute the contract or work to be performed;
4. Bidder certifies that it is in full compliance with the Federal Highway Administrative Rules on Controlled Substances and Alcohol Use and Testing, 49 C.F.R. Parts 40 and 382 and that all employee drivers are currently participating in a drug and alcohol testing program pursuant to the Rules;
5. Bidder further certifies that it is not delinquent in the payment of any tax administered by the Department of Revenue, or that Bidder is contesting its liability for the tax delinquency or the amount of a tax delinquency in accordance with the procedures established by the appropriate Revenue Act. Bidder further certifies that if it owes any tax payment(s) to the Department of Revenue, Bidder has entered into an agreement with the Department of Revenue for the payment of all such taxes that are due, and Bidder is in compliance with the agreement.

BIDDER'S CERTIFICATION (page 2 of 3)

BY: William Bowes
Bidder's Authorized Agent

36-3494492

FEDERAL TAXPAYER IDENTIFICATION NUMBER

or _____
Social Security Number

Subscribed and sworn to before me

Official Seal: JULIE C HEIDERMAN, NOTARY PUBLIC - STATE OF ILLINOIS, My Commission Expires: 10/18/14. This seal is stamped over the text: this 3 day of Feb., 20 11. A signature is written over the seal.

(Fill Out Applicable Paragraph Below)

(a) Corporation

The Bidder is a corporation organized and existing under the laws of the State of Illinois, which operates under the Legal name of Chicago Land Paving Contractors Inc., and the full names of its Officers are as follows:

President: Kevin Meertz

Secretary: William R. Bowes

Treasurer: Kevin Meertz

and it does have a corporate seal. (In the event that this bid is executed by other than the President, attach hereto a certified copy of that section of Corporate By-Laws or other authorization by the Corporation which permits the person to execute the offer for the corporation.)

(b) Partnership

Signatures and Addresses of All Members of Partnership:

BIDDER'S CERTIFICATION (page 3 of 3)

The partnership does business under the legal name of: _____
which name is registered with the office of _____ in the state of _____.

(c) Sole Proprietor

The Supplier is a Sole Proprietor whose full name is: _____
and if operating under a trade name, said trade name is: _____
which name is registered with the office of _____ in the state of _____.

6. Are you willing to comply with the Village's insurance requirements within 13 days of the award of the contract?

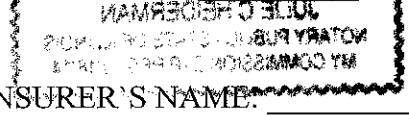
INSURER'S NAME:  Corkill Insurance Agency

AGENT: Paul F. Praxmarer

Street Address: 25 NW Point Blvd.

City, State, Zip Code: Elk Grove Village IL 60007

Telephone Number: 847-437-2656

I/We hereby affirm that the above certifications are true and accurate and that I/we have read and understand them.

Print Name of Company: Chicageland Paving Contractors, Inc.

Print Name and Title of Authorizing Signature: William R. Bues

Signature: W R Bues

Date: 2/3/2011



CERTIFICATE OF LIABILITY INSURANCE

OP ID: YR

DATE (MM/DD/YYYY)

01/31/11

THIS CERTIFICATE IS ISSUED AS A MATTER OF INFORMATION ONLY AND CONFERS NO RIGHTS UPON THE CERTIFICATE HOLDER. THIS CERTIFICATE DOES NOT AFFIRMATIVELY OR NEGATIVELY AMEND, EXTEND OR ALTER THE COVERAGE AFFORDED BY THE POLICIES BELOW. THIS CERTIFICATE OF INSURANCE DOES NOT CONSTITUTE A CONTRACT BETWEEN THE ISSUING INSURER(S), AUTHORIZED REPRESENTATIVE OR PRODUCER, AND THE CERTIFICATE HOLDER.

IMPORTANT: If the certificate holder is an ADDITIONAL INSURED, the policy(ies) must be endorsed. If SUBROGATION IS WAIVED, subject to the terms and conditions of the policy, certain policies may require an endorsement. A statement on this certificate does not confer rights to the certificate holder in lieu of such endorsement(s).

PRODUCER Corkill Insurance Agency, Inc. 25 Northwest Pt Blvd Ste 625 Elk Grove Village, IL 60007 Paul F. Praxmarer		847-758-1000 847-758-1200	CONTACT NAME: PHONE (A/C, No, Ext): FAX (A/C, No): E-MAIL ADDRESS: PRODUCER CUSTOMER ID #: CHICL-1
INSURED Chicagoland Paving Inc. 225 Telsor Road Lake Zurich, IL 60047	INSURER(S) AFFORDING COVERAGE		NAIC #
	INSURER A: Harleysville Insurance A-		14516
	INSURER B: AGCS Marine Insurance Co A+		22837
	INSURER C: St. Paul Fire & Marine Ins A+		
	INSURER D:		
	INSURER E:		
		INSURER F:	

COVERAGES**CERTIFICATE NUMBER:****REVISION NUMBER:**

THIS IS TO CERTIFY THAT THE POLICIES OF INSURANCE LISTED BELOW HAVE BEEN ISSUED TO THE INSURED NAMED ABOVE FOR THE POLICY PERIOD INDICATED. NOTWITHSTANDING ANY REQUIREMENT, TERM OR CONDITION OF ANY CONTRACT OR OTHER DOCUMENT WITH RESPECT TO WHICH THIS CERTIFICATE MAY BE ISSUED OR MAY PERTAIN, THE INSURANCE AFFORDED BY THE POLICIES DESCRIBED HEREIN IS SUBJECT TO ALL THE TERMS, EXCLUSIONS AND CONDITIONS OF SUCH POLICIES. LIMITS SHOWN MAY HAVE BEEN REDUCED BY PAID CLAIMS.

INSR LTR	TYPE OF INSURANCE	ADDL INSR	SUBR WVD	POLICY NUMBER	POLICY EFF (MM/DD/YYYY)	POLICY EXP (MM/DD/YYYY)	LIMITS
A	GENERAL LIABILITY			MPA18565B	02/24/10	02/24/11	EACH OCCURRENCE \$ 1,000,000
	<input checked="" type="checkbox"/> COMMERCIAL GENERAL LIABILITY <input type="checkbox"/> CLAIMS-MADE <input checked="" type="checkbox"/> OCCUR GEN'L AGGREGATE LIMIT APPLIES PER: <input type="checkbox"/> POLICY <input checked="" type="checkbox"/> PROJECT <input type="checkbox"/> LOC						DAMAGE TO RENTED PREMISES (Ea occurrence) \$ 100,000 MED EXP (Any one person) \$ 5,000 PERSONAL & ADV INJURY \$ 1,000,000 GENERAL AGGREGATE \$ 2,000,000 PRODUCTS - COMP/OP AGG \$ 2,000,000
A	AUTOMOBILE LIABILITY			BA18692B	02/24/10	02/24/11	COMBINED SINGLE LIMIT (Ea accident) \$ 1,000,000
	<input checked="" type="checkbox"/> ANY AUTO <input checked="" type="checkbox"/> ALL OWNED AUTOS <input checked="" type="checkbox"/> SCHEDULED AUTOS <input checked="" type="checkbox"/> HIRED AUTOS <input checked="" type="checkbox"/> NON-OWNED AUTOS						BODILY INJURY (Per person) \$ BODILY INJURY (Per accident) \$ PROPERTY DAMAGE (Per accident) \$ \$ \$
A	UMBRELLA LIAB			CMB37517B	02/24/10	02/24/11	EACH OCCURRENCE \$ 5,000,000
	<input checked="" type="checkbox"/> EXCESS LIAB <input checked="" type="checkbox"/> OCCUR <input type="checkbox"/> CLAIMS-MADE DEDUCTIBLE <input checked="" type="checkbox"/> RETENTION \$						AGGREGATE \$ 5,000,000 \$ \$
A	WORKERS COMPENSATION AND EMPLOYERS' LIABILITY			WC37524B	02/24/10	02/24/11	<input checked="" type="checkbox"/> WC STATUTORY LIMITS <input type="checkbox"/> OTHER
	ANY PROPRIETOR/PARTNER/EXECUTIVE OFFICER/MEMBER EXCLUDED? (Mandatory in NH) If yes, describe under DESCRIPTION OF OPERATIONS below	Y/N	N/A				E.L. EACH ACCIDENT \$ 1,000,000
							E.L. DISEASE - EA EMPLOYEE \$ 1,000,000 E.L. DISEASE - POLICY LIMIT \$ 1,000,000
C	Excess Liability			Q101201652	02/24/10	02/24/11	Limit: 5,000,000 SIR: 0

DESCRIPTION OF OPERATIONS / LOCATIONS / VEHICLES (Attach ACORD 101, Additional Remarks Schedule, if more space is required)

CERTIFICATE HOLDER**CANCELLATION**

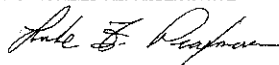
SAMPLEC SAMPLE CERTIFICATE	SHOULD ANY OF THE ABOVE DESCRIBED POLICIES BE CANCELLED BEFORE THE EXPIRATION DATE THEREOF, NOTICE WILL BE DELIVERED IN ACCORDANCE WITH THE POLICY PROVISIONS. AUTHORIZED REPRESENTATIVE 
--	---

© 1988-2009 ACORD CORPORATION. All rights reserved.

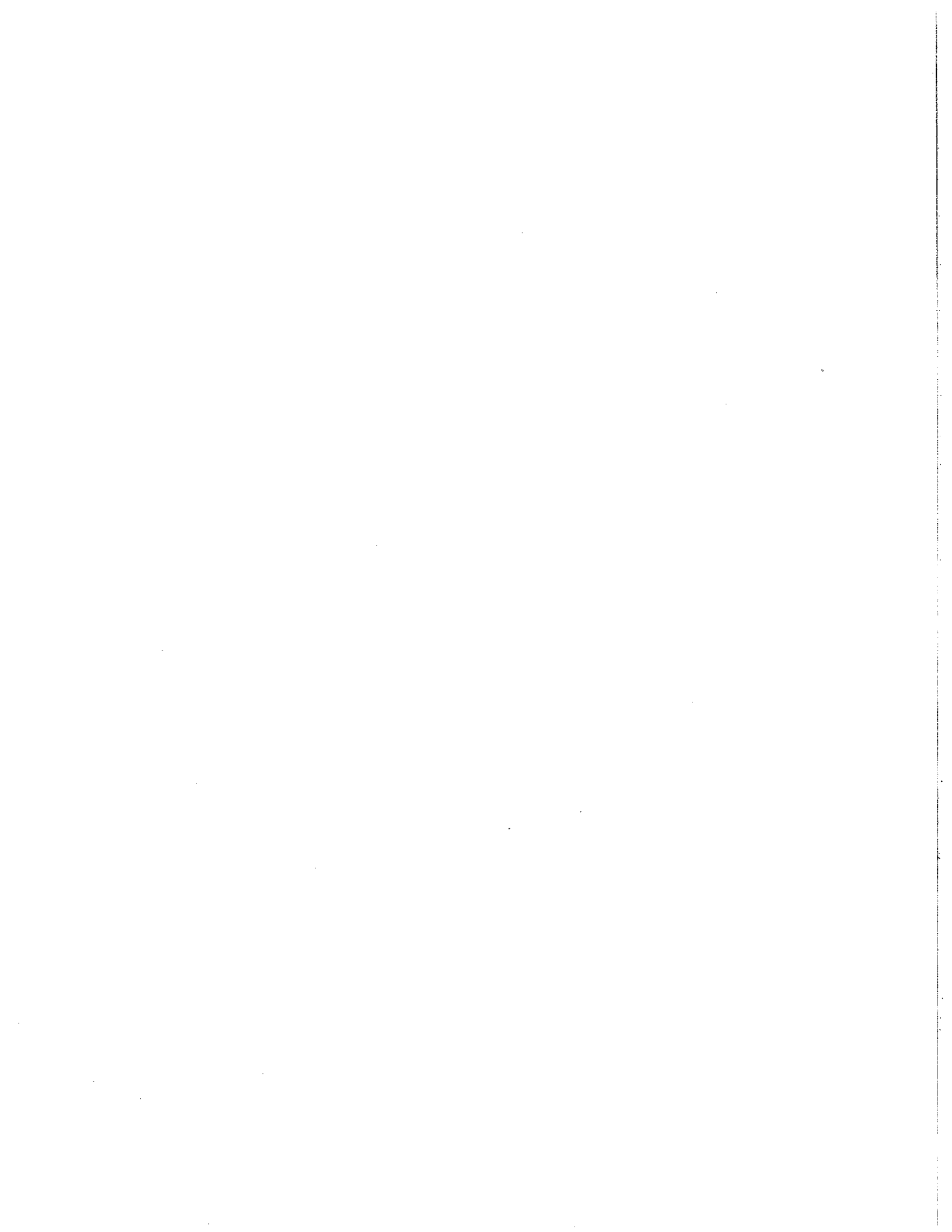

Chicagoland Paving Contractors, Inc.

225 Telsler Road

Lake Zurich, IL 60047

Phone: 847-550-9681

Fax: 847-550-9684

CERTIFICATE OF RESOLUTION

I, KEVIN MEARTZ, President of CHICAGOLAND PAVING CONTRACTORS, INC., an Illinois corporation (the Corporation) hereby certifies that the following resolutions were unanimously adopted by the Shareholders and Directors of the Corporation by consent of the Shareholders and Directors dated May 26, 1988:

RESOLVED, that CHICAGOLAND PAVING CONTRACTORS, INC., an Illinois Corporation (the Corporation) authorizes WILLIAM BOWES, to have the authority to sign and enter into a contract on behalf of CHICAGOLAND PAVING CONTRACTORS, INC.

FURTHER RESOLVED, that any one or more of the President and any Secretary or Assistant Secretary of the Corporation are authorized, empowered and directed to execute and deliver on behalf of the Corporation, such documents and agreements as they or any of them determine to be necessary or advisable to effectuate the foregoing resolutions.

Executed in Lake Zurich, IL on May 26, 1988

By:

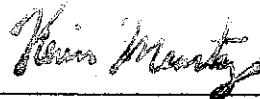

KEVIN MEARTZ, President



MUNICIPAL REFERENCE LIST

Municipality: see attached List

Address: _____

Contact Name: _____ Phone #: _____

Name of Project: _____

Contract Value: _____ Date of Completion: _____

Municipality: _____

Address: _____

Contact Name: _____ Phone #: _____

Name of Project: _____

Contract Value: _____ Date of Completion: _____

Municipality: _____

Address: _____

Contact Name: _____ Phone #: _____

Name of Project: _____

Contract Value: _____ Date of Completion: _____

Municipality: _____

Address: _____

Contact Name: _____ Phone #: _____

Name of Project: _____

Contract Value: _____ Date of Completion: _____

Municipality: _____

Address: _____

Contact Name: _____ Phone #: _____

Name of Project: _____

Contract Value: _____ Date of Completion: _____

SUBCONTRACTORS LIST

The Bidder hereby states the following items of work will not be performed by its organization. (List items to be subcontracted as well as the names, addresses and phone numbers of the subcontractors.)

1) Kristina Type of Work concrete

Addr: 10N911 Glen Echo St. City Elgin State IL Zip 60120

2) _____ Type of Work _____

Addr: _____ City _____ State _____ Zip _____

3) _____ Type of Work _____

Addr: _____ City _____ State _____ Zip _____

4) _____ Type of Work _____

Addr: _____ City _____ State _____ Zip _____

5) _____ Type of Work _____

Addr: _____ City _____ State _____ Zip _____

6) _____ Type of Work _____

Addr: _____ City _____ State _____ Zip _____

7) _____ Type of Work _____

Addr: _____ City _____ State _____ Zip _____

8) _____ Type of Work _____

Addr: _____ City _____ State _____ Zip _____

STREET PROJECT REFERENCE LIST 2010

Village of Morton Grove

2010 Street Improvement Program MFT
Contract Amount: \$ 290,152.50
Mr. Tavis Farmer
Village of Morton Grove
847-663-3905

Village of Lombard

FY 2010 Asphalt Paving & Patching Program
Contract Amount: \$ 1,038,829.24
Mr. Chris Welch
Village of Lombard
630-620-5740

Village of Inverness

2010 Road Maintenance Program
Contract Amount: \$ 1,949,999.00
Mr. Steven Berecz
Gewalt Hamilton
847-478-9700 x 113

Village of East Dundee

2010 East Dundee ERP 1 & 2
Contract Amount: \$ 415,960.35
Mr. Joseph D. Heinz
Gerald L. Heinz & Associates
847-426-4533

Village of Northbrook

Revere Drive Reconstruction
Contract Amount: \$ 818,104.55
Mr. Michael Bukolt
Village of Northbrook
847-272-4711

Village of Wilmette

Alley Surface Patching
Contract Amount: \$ 18,000.00
Mr. Scott Hilts
Village of Wilmette
847-853-7628

Village of Long Grove

Long Grove 2010 Street Program / Various Streets
Contract Amount: \$ 129,620.00
Mr. Brandt Zentner
ESI Consultants
630-420-1700

Village of Riverside

2010 MFT Street Improvements
Contract Amount: \$ 268,950.10
Ms. Natalie Nelson
James J. Benes & Associates
630-719-7570

Village of Barrington Hills

2010 Road Program
Contract Amount: \$ 569,256.50
Mr. Dan Strahan
Gewalt Hamilton
847-855-1100

City of Highland Park

2010 Asphalt Patching Program
Contract Amount: \$ 200,000.00
Mr. William Hall
City of Highland Park
847-432-0807

Village of Palatine

2010 Street Resurfacing Phase 2
Contract Amount: \$ 370,222.25
Mr. George Ruppert
Village of Palatine
847-359-9025

Village of Winnetka

2010 Resurfacing Various Streets
Contract Amount: \$ 204,900.00
Ms. Susan Chen
Village of Winnetka
847-716-3530

Village of Stone Park

2010 Alley Rehabilitation
Contract Amount: \$ 85,925.00
Mr. Kevin K. Pelli
McClure Engineering
847-336-7100

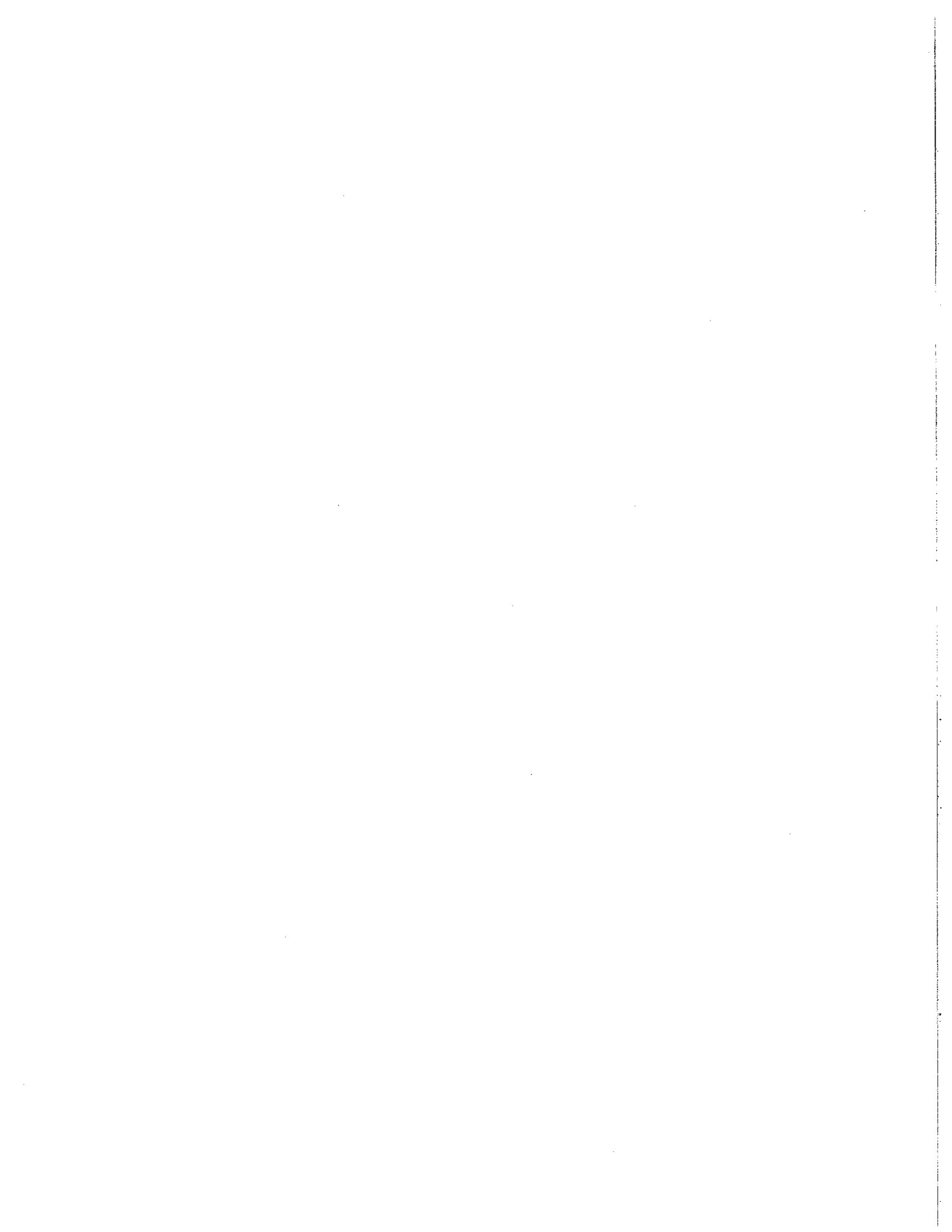

Village of Downers Grove



VENDOR W-9 REQUEST FORM

The law requires that we maintain accurate taxpayer identification numbers for all individuals and partnerships to whom we make payments, because we are required to report to the I.R.S all payments of \$600 or more annually. We also follow the I.R.S. recommendation that this information be maintained for all payees including corporations.

Please complete the following substitute W-9 letter to assist us in meeting our I.R.S. reporting requirements. The information below will be used to determine whether we are required to send you a Form 1099. Please respond as soon as possible, as failure to do so will delay our payments.

BUSINESS (PLEASE PRINT OR TYPE):

NAME: ChicagoLand Paving Contractors Inc.

ADDRESS: 225 Telser Rd.

CITY: Lake Zurich

STATE: IL

ZIP: 60047

PHONE: 847.550.9681 FAX: 847.550.9684

TAX ID #(TIN): 36-3494492

(If you are supplying a social security number, please give your full name)

REMIT TO ADDRESS (IF DIFFERENT FROM ABOVE):

NAME: _____

ADDRESS: _____

CITY: _____

STATE: _____ ZIP: _____

TYPE OF ENTITY (CIRCLE ONE):

- Individual
- Sole Proprietor
- Partnership
- Medical
- Charitable/Nonprofit
- Limited Liability Company - Individual/Sole Proprietor
- Limited Liability Company-Partnership
- Limited Liability Company-Corporation
- Corporation
- Government Agency

SIGNATURE: W R Jones

DATE: 2/3/2011

Apprenticeship and Training Certification

(Does not apply to federal aid projects. Applicable only to maintenance and construction projects that use Motor Fuel Tax funds or state grant monies)

Name of Bidder: Chicagoland Paving Contractors Inc.

In accordance with the provisions of Section 30-22 (6) of the Illinois Procurement Code, the bidder certifies that it is a participant, either as an individual or as part of a group program, in the approved apprenticeship and training programs applicable to each type of work or craft that the bidder will perform with its own forces. The bidder further certifies for work that will be performed by subcontract that each of its subcontractors submitted for approval either (a) is, at the time of such bid, participating in an approved, applicable apprenticeship and training program; or (b) will, prior to commencement of performance of work pursuant to this contract, begin participation in an approved apprenticeship and training program applicable to the work of the subcontract. The Illinois Department of Labor, at any time before or after award, may require the production of a copy of each applicable Certificate of Registration issued by the United States Department of Labor evidencing such participation by the contractor and any or all of its subcontractors. Applicable apprenticeship and training programs are those that have been approved and registered with the United States Department of Labor. The bidder shall list in the space below, the official name of the program sponsor holding the Certificate of Registration for all of the types of work or crafts in which the bidder is a participant and that will be performed with the bidder's forces. Types of work or craft work that will be subcontracted shall be included and listed as subcontract work. The list shall also indicate any type of work or craft job category that does not have an applicable apprenticeship or training program. **The bidder is responsible for making a complete report and shall make certain that each type of work or craft job category that will be utilized on the project is accounted for and listed. Return this with the bid.**

The requirements of this certification and disclosure are a material part of the contract, and the contractor shall require this certification provision to be included in all approved subcontracts. In order to fulfill this requirement, it shall not be necessary that an applicable program sponsor be currently taking or that it will take applications for apprenticeship, training or employment during the performance of the work of this contract.

Print Name and Title of Authorizing Signature: William R. Baus, VP.

Signature: W R Baus

Date: 2/3/2011

BUY AMERICA CERTIFICATION

Certification requirement for procurement of steel, iron, or manufactured products when Federal funds (Grant Agreement or Cooperative Agreement) are used.

Instructions:

Bidder to complete the Buy America Certification listed below. Bidder shall certify EITHER COMPLIANCE OR NON-COMPLIANCE (not both). This Certification MUST BE submitted with the Bidder's bid response.

Special Note: Make sure you have signed only one of the above statements – either Compliance OR Non-Compliance (not both).

Certificate of Compliance

The bidder or offeror hereby certifies that it will meet the requirements of 49 U.S.C. 5323(j)(1), as amended, and the applicable regulations in 49 CFR Part 661.

Signature W R Gorman

Company Name Chicago Land Paving Contractors, Inc.

Title V.P.

Date 2-3-2011

Certificate of Non-Compliance

The bidder or offeror hereby certifies that it cannot comply with the requirements of 49 U.S.C. 5323(j)(1), as amended, and 49 C.F.R. 661, but it may qualify for an exception pursuant to 49 U.S.C. 5323(j)(2)(A), 5323(j)(2)(B), or 5323(j)(2)(D), and 49 C.F.R. 661.7.

Signature _____

Company Name _____

Title _____

Date _____

AFTER THIS CERTIFICATE HAS BEEN EXECUTED, A BIDDER MAY NOT SEEK A WAIVER.

Note: The U.S./Canadian Free Trade Agreement does not supersede the Buy America requirement.

Suspension or Debarment Certificate

Non-Federal entities are prohibited from contracting with or making sub-awards under covered transactions to parties that are suspended or debarred or whose principals are suspended or debarred. Covered transactions include procurement for goods or services equal to or in excess of \$100,000.00 contractors receiving individual awards for \$100,000.00 or more and all sub-recipients must certify that the organization and its principals are not suspended or debarred.

By submitting this offer and signing this certificate, the bidder certifies to the best of its knowledge and belief, that the company and its principals:

1. Are not presently debarred, suspended, proposed for debarment, declared ineligible or voluntarily excluded from covered transactions by any federal, state or local governmental entity, department or agency.
2. Have not within a three-year period preceding this proposal been convicted of or had a civil judgment rendered against them for commission of fraud or a criminal offense in connection with obtaining, attempting to obtain, or performing a public (Federal, State or local) transaction or contract under a public transaction, or convicted of or had a civil judgment against them for a violation of Federal or state antitrust statutes or commission of embezzlement, theft, forgery, bribery, falsification or destruction of records, making false statements, or receiving stolen property;
3. Are not presently indicted for or otherwise criminally or civilly charged by a governmental entity (Federal, State, or local) with commission of any of the offenses enumerated in paragraph (2) of this certification: and
4. Have not within a three-year period preceding this application/proposal/contract had one or more public transactions (Federal, State or local) terminated for cause or default.

If the bidder is unable to certify to any of the statements in this certification, bidder shall attach an explanation to this certification.

Company Name: Chicagoland Paving Contractors Inc.

Address: 225 Telsa Rd.

City: Lake Zurich Zip Code: 60047

Telephone: (847) 550-9681 Fax Number: (847) 550-9684

E-mail Address: chicagoland1@sbcglobal.net

Authorized Company Signature: W R Zomer

Print Signature Name: William Baues Title of Official: V.P.

Date: 2.3.2011

CAMPAIGN DISCLOSURE CERTIFICATE

Any contractor, proposer, bidder or vendor who responds by submitting a bid or proposal to the Village of Downers Grove shall be required to submit with its bid submission, an executed Campaign Disclosure Certificate, attached hereto.

The Campaign Disclosure Certificate is required pursuant to the Village of Downers Grove Council Policy on Ethical Standards and is applicable to those campaign contributions made to any member of the Village Council.

Said Campaign Disclosure Certificate requires any individual or entity bidding to disclose campaign contributions, as defined in Section 9-1.4 of the Election Code (10 ILCS 5/9-1.4), made to current members of the Village Council within the five (5) year period preceding the date of the bid or proposal release.

By signing the bid documents, contractor/proposer/bidder/vendor agrees to refrain from making any campaign contributions as defined in Section 9-1.4 of the Election Code (10 ILCS 5/9-1.4) to any Village Council member and any challengers seeking to serve as a member of the Downers Grove Village Council.

Under penalty of perjury, I declare: _____

Bidder/vendor has not contributed to any elected Village position within the last five (5) years.

W R Bowes
Signature

William Bowes
Print Name

Bidder/vendor has contributed a campaign contribution to a current member of the Village Council within the last five (5) years.

Print the following information:

Name of Contributor: _____
(company or individual)

To whom contribution was made: _____

Year contribution made: _____ Amount: \$ _____

Signature

Print Name

BID SUBMITTAL CHECKLIST

Each Bidder's Bid Package must be submitted with all requisite forms properly completed, and all documentation included. The following list is not all-inclusive, but is designed to facilitate a good, competitive bidding environment.

1. Instructions to Bidders read and understood. Any questions must be asked according to the instructions.
2. Cover sheet filled-in
3. Bid Form copies filled-in. All copies must have original signatures and seals on them.
4. Bid Bond or cashier's check enclosed with bid package.
5. Schedule of Prices completed. Check your math!
6. Bidder Certifications signed and sealed.
7. Letter from Surety ensuring issuance of Performance and Labor Bonds.
8. Letter from Insurance Agent or Carrier ensuring issuance of required job coverage.
9. Municipal Reference List completed.
10. Vendor request form W-9 completed.
11. Bid package properly sealed and labeled before delivery. If sending by mail or messenger, enclose in a second outer envelope or container. Project plan sheets do not have to be included with the bid package.



UNITED FIRE & CASUALTY COMPANY
CEDAR RAPIDS, IOWA

BID BOND

Approved by The American Institute of Architects, A.I.A. Document No. A 310 February 1970 Edition

KNOW ALL MEN BY THESE PRESENTS, that we Chicagoland Paving Contractors, Inc.

Lake Zurich, IL 60047

_____ as Principal, hereinafter called the Principal,
and the UNITED FIRE & CASUALTY COMPANY, a corporation duly organized under the laws of the State of IOWA,
as Surety, hereinafter called the Surety, are held and firmly bound unto Village of Downers Grove,
Downers Grove, IL 60515

_____ as Obligee, hereinafter called the Obligee,
in the sum of Five Percent of total amount bid----- Dollars
(\$ 5% of total amount bid-----), for the payment of which sum well and truly to be made, the said principal and the
said Surety, bind ourselves, our heirs, executors, administrators, successors and assigns, jointly and severally, firmly by these
presents.

WHEREAS, the Principal has submitted a bid for Pavement Patching

NOW, THEREFORE, if the Obligee shall accept the bid of the Principal and the Principal shall enter into a contract with the
Obligee in accordance with the terms of such bid, and give such bond or bonds as may be specified in the bidding or contract
documents with good and sufficient surety for the faithful performance of such contract and for the prompt payment of labor
and material furnished in the prosecution thereof, or in the event of the failure of the Principal to enter such contract and
give such bond or bonds, if the Principal shall pay to the Obligee the difference not to exceed the penalty hereof between
the amount specified in said bid and such larger amount for which the Obligee may in good faith contract with another party
to perform the work covered by said bid, then this obligation shall be null and void, otherwise to remain in full force and
effect.

Signed and sealed this 3rd day of February A.D. ~~19~~ 2011

[Signature]
(WITNESS)

Chicagoland Paving Contractors, Inc. (Seal)
(PRINCIPAL)

W R Gorman, P.
(TITLE)

[Signature]
(WITNESS)

UNITED FIRE & CASUALTY COMPANY (Seal)
(SURETY)

By [Signature]
Jeremiah G. Crise
(ATTORNEY IN FACT)



February 1, 2011

ADDENDUM-01

CFB-0-2011/TT

PAVEMENT PATCHING

Due to the approaching snowstorm the above bid deadline has been rescheduled to Friday, February 4, 2010, at 2:15 P.M.

*v/o Damers' One
postponed*

Sincerely

Theresa H. Tarka

Purchasing

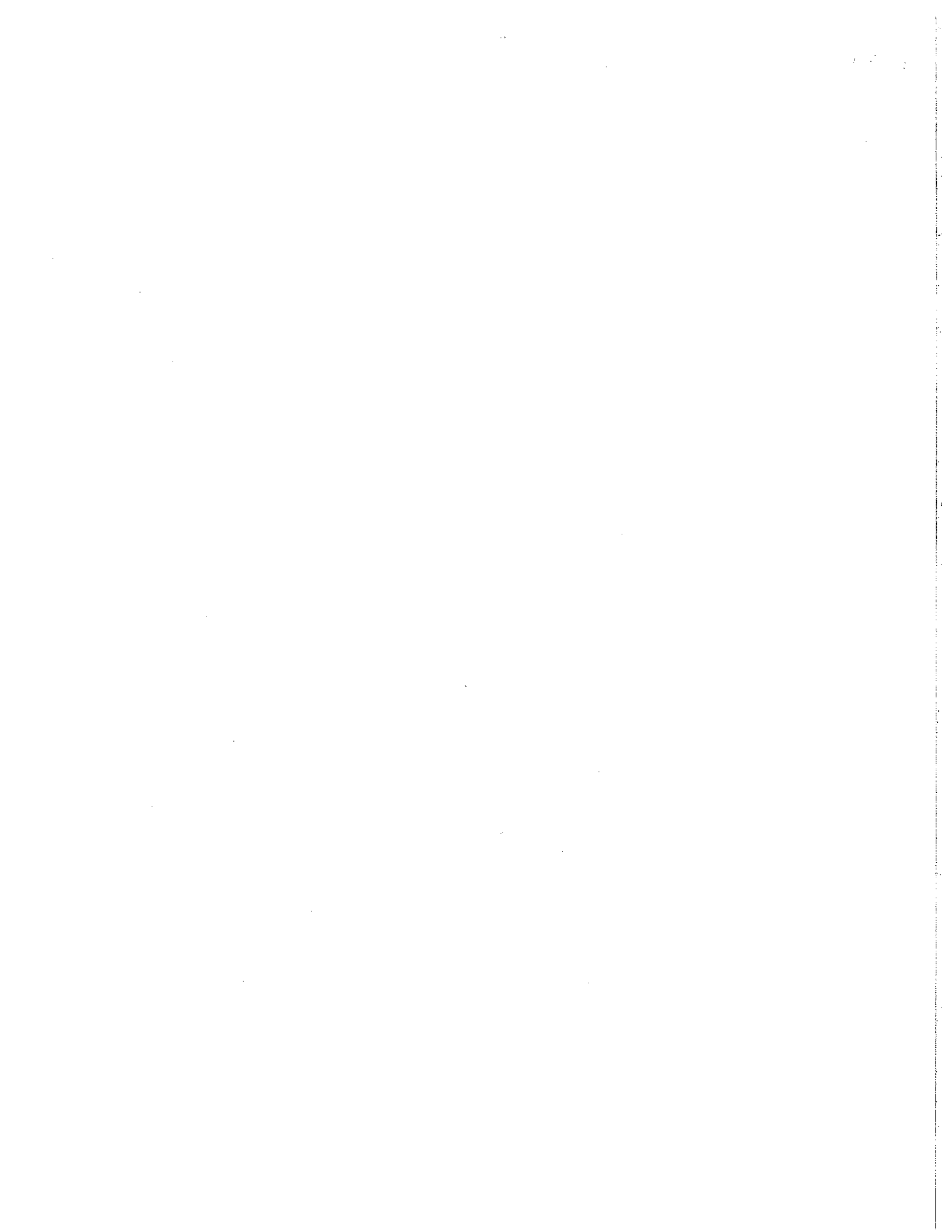

Addendum - Fax Notification Sheet

Village of Downers Grove

801 Burlington Avenue
Downers Grove, IL. 60515

Call for Bids

PAVEMENT PATCHING

CFB -0-0-2011/TT

A newly released Addendum ("PAVEMENT PATCHING") exists on the Onvia DemandStar system. You may go online at www.demandstar.com and download the Addendum as an Adobe PDF directly. The Addendum may also be obtained by calling the Onvia DemandStar fulfillment number at (800) 711-1712.

Onvia DemandStar

509 Olive Way, Suite 400, Seattle, WA 98101

Phone (800) 711-1712 / Fax (206) 373-9630

B:219653

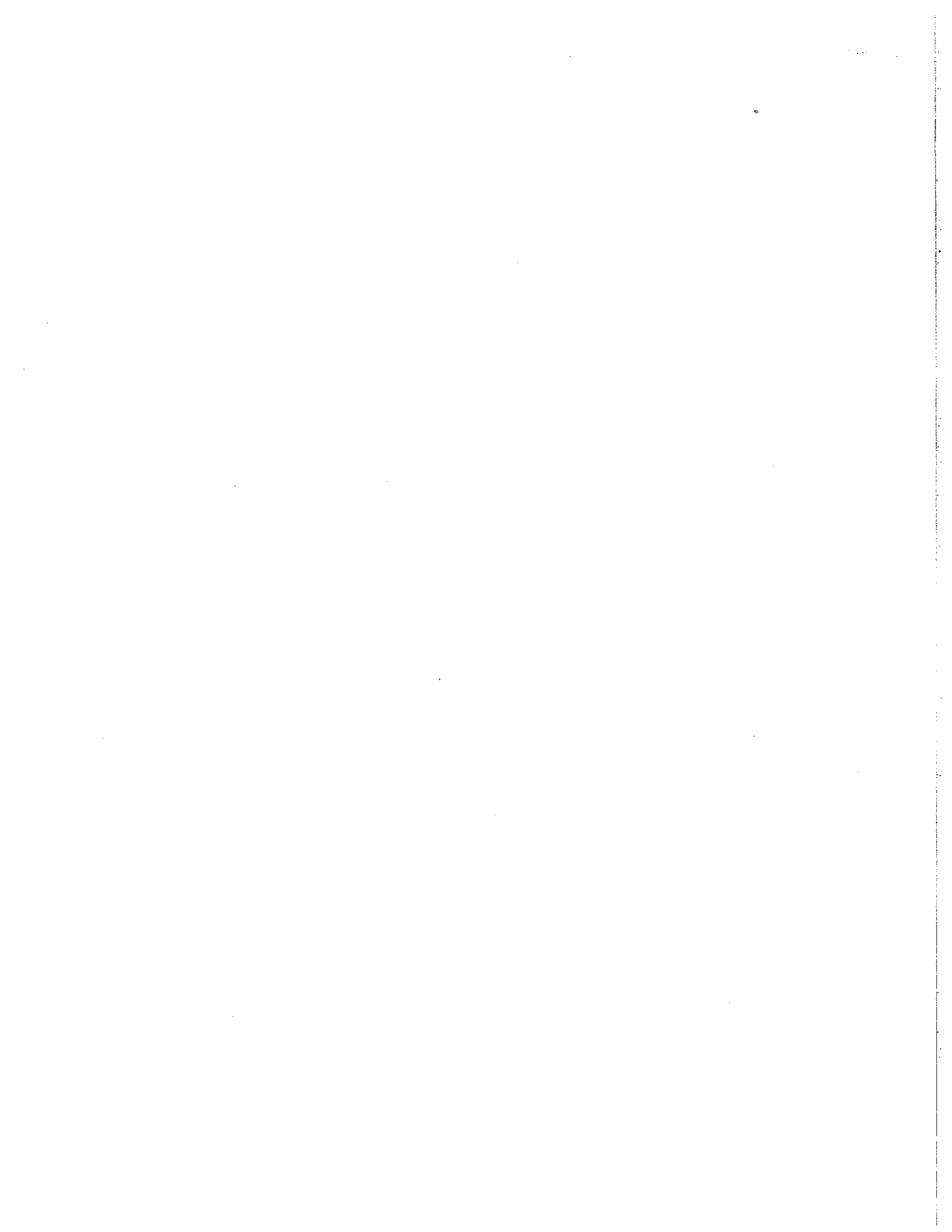

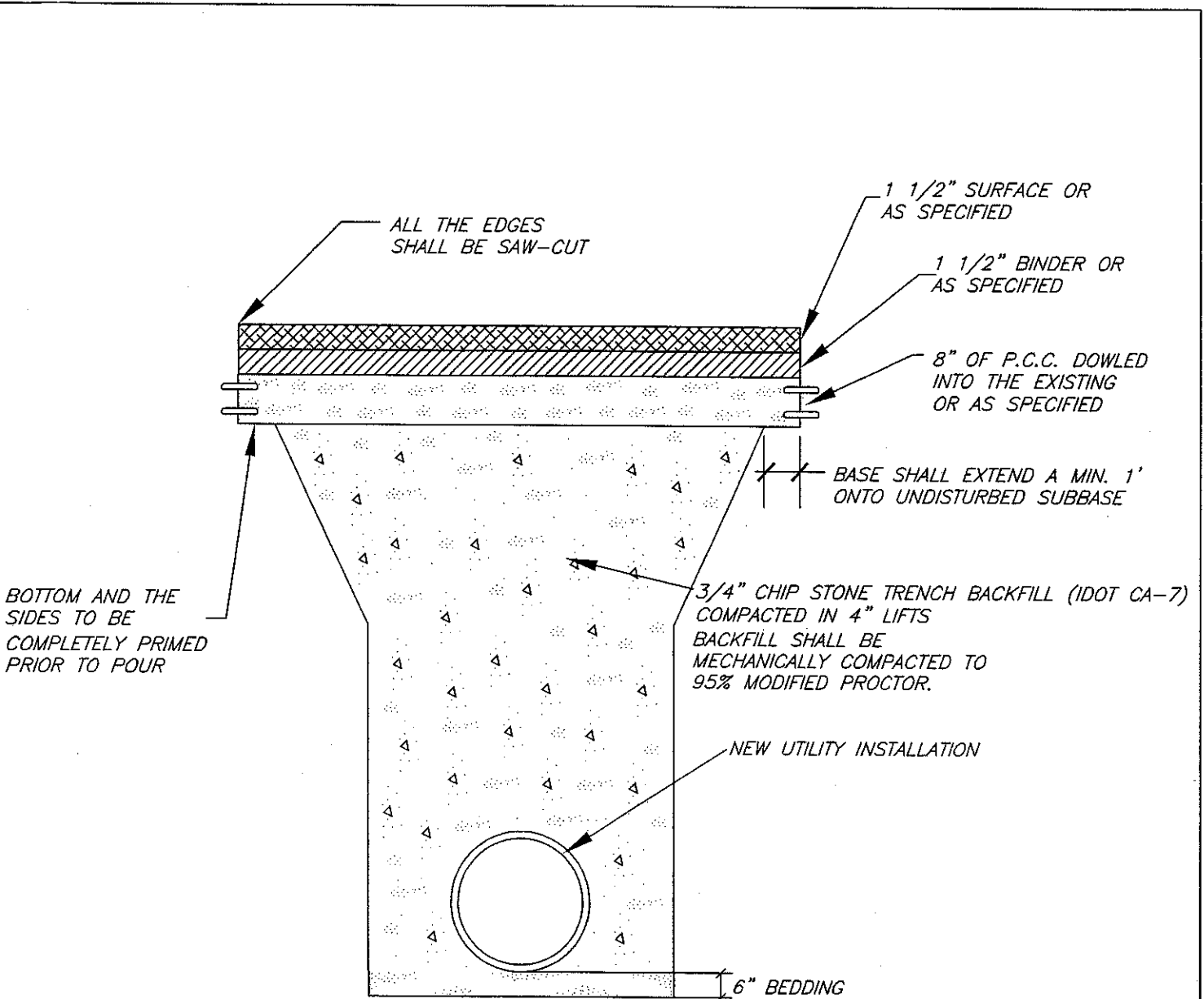

NOTE

- * ALL CONSTRUCTION MATERIALS AND METHODS SHALL COMPLY WITH STANDARD SPECIFICATIONS FOR WATER AND SEWER MAIN CONSTRUCTION IN THE STATE OF ILLINOIS AND THE "STANDARD SPECIFICATIONS FOR ROAD & BRIDGE CONSTRUCTION" AS ADOPTED BY THE ILLINOIS DEPARTMENT OF TRANSPORTATION. UNLESS OTHERWISE SPECIFIED HEREIN, OR BY THE DIRECTOR OF PUBLIC WORKS.
- * ALL ROADWAYS SHALL REMAIN OPEN TO TRAFFIC WITH AT LEAST 1/2 THE WIDTH. ALL BRACING SHALL COMPLY WITH THE "STANDARD SPECIFICATIONS FOR ROAD AND BRIDGE CONSTRUCTION" AS ADOPTED BY THE ILLINOIS DEPARTMENT OF TRANSPORTATION AND SHALL BE APPROVED BY THE VILLAGE, PRIOR TO COMMENCEMENT OF WORK.
- * ANY FLARE OR EXCAVATION BEYOND THE LIMITS SPECIFIED SHALL BE BACKFILLED ACCORDINGLY AT THE EXPENSE OF THE CONTRACTOR.
- * IF MORE THAN 30% OF THE ROADWAY WIDTH IS AFFECTED, THE ENTIRE WIDTH OF THE ROADWAY MUST BE RESURFACED.
- * SEE PVT-22 FOR FURTHER DETAILS
- * ALL STREET OPENINGS MUST BE FULLY RESTORED WITHIN TEN DAYS.

N.T.S.	DATE	REVISIONS	DRAWN BY	APPVD BY	STANDARD DETAIL
	02/20/07	//////	J.M.L.	M.D.M.	<p>STREET OPENING BITUMINOUS WITH CONCRETE BASE</p>
DRAWING NO. PVT-19					
I:\PW - ENG & TRANSPORTATION\DESIGN DETAILS-FEB 07\PAVEMENT\PVT-19					

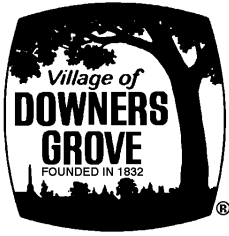

Village of Downers Grove Contractor Evaluation

Contractor: Chicagoland Paving Contractors, Inc.

Project: 2010 Pavement Patching

Primary Contact: William Bowes Phone: 847-550-9681

Time Period: May through October 2010

On Schedule (allowing for uncontrollable circumstances) X yes no

Provide details if early or late completion: N/A

Change Orders (attach information if needed): N/A

Difficulties / Positives:

Contractor did an excellent job in both spring and fall pavement patching.

Interaction with public:

excellent X good average poor

(Attach information on any complaints or compliments)

General Level of Satisfaction with work:

X Well Satisfied Satisfied Not Satisfied

Should the Village contract with this vendor in the future? X Yes No

Reviewer: John Tucker, Street Division Manager – Technical Services

Date: 12-06-2010